

August 12, 2004
10077.008

Oregon Department of Environmental Quality
Northwest Region
2020 SW Fourth Avenue
Suite 400
Portland, Oregon 97201-4987

VIA Hand Delivery

**Subject: RI/FS Technical Memorandum
Historical Shell/Niemi/Mobil Petroleum Pipeline Investigation and
Decommissioning Report
Astoria Area-Wide Petroleum Site
Astoria, Oregon
DEQ ECSI File #2277**

Dear Ms. Coates:

Enclosed are four copies of the above-referenced document. This report is being submitted to you on behalf of Shell Oil Company and ExxonMobil. This report is intended to comply with the terms of DEQ Order No. ECSR-NWR-01-11.

Please call me at (503)768-5121 if you have any questions or comments.

Sincerely,
EnviroLogic Resources, Inc.

Thomas J. Calabrese, RG, CWRE
Principal/Hydrogeologist
Project Manager
cc: Distribution list attached

Ms. Anna Coates
August 12, 2004
Page 2

**ASTORIA AREA-WIDE PETROLEUM SITE
Distribution List**

- 1 Anna Coates, DEQ Project Manager, Site Response
 - 1 Mike Lilly, Attorney for Port of Astoria
 - 1 Peter Gearin, Port of Astoria
 - 1 Tom Calabrese, *EnviroLogic Resources, Inc.*, Consultant for PoA and AAW PRP Group
 - 1 Max Miller, Tonkon Torp, Attorney for McCall Oil and Chemical Corporation
 - 1 Ted McCall, McCall Oil and Chemical Corporation
 - 1 John Edwards, Anchor Environmental, LLC, Consultant for McCall Oil and Chemical Corp
 - 1 Cary E. Bechtolt, Niemi Oil Company
 - 1 Allan B. Bakalian, Marten Law Group, PLLC, Attorney for Niemi Oil Company
 - 1 Kurt Harrington, AMEC, Inc., Consultant for Niemi Oil Company
 - 1 Ed Platt, Shell Oil Company
 - 1 Rick Glick, Davis Wright Tremaine, Attorney for Shell Oil Company
 - 1 Leon Lahiere, Hart Crowser, Consultant for Shell Oil Company
 - 1 Brian Harris, Harris Enterprises
 - 1 Larry Vandermay, Flying Dutchman
 - 1 David Bartz & Neal Hueske, Schwabe Williamson & Wyatt, Attorney for Flying Dutchman
 - 1 Jerry Hodson, Miller Nash, Attorney for Harris Enterprises
 - 1 Lon Yandell, Kleinfelder, Consultant for Harris Enterprises
 - 1 Richard Delphia, Delphia Oil Company
 - 1 Chuck Smith, Attorney for Delphia Oil Company
 - 1 Alistaire Clary, Maul Foster Alongi, Consultant for Delphia Oil Company
 - 1 Cheryl Morrison, ChevronTexaco Products Company
 - 1 Charles Lambert, Attorney for ChevronTexaco Products Company
 - 1 Gerry Koschal, SAIC, Consultant for ChevronTexaco Products Company
 - 1 Brian Jacobson, Qwest Communications International, Inc.
 - 1 David Bledsoe, Perkins Coie LLP, Attorney for Qwest Communications International, Inc.
 - 1 Donna LaCombe, Tetra Tech EM, Inc., Consultant for Qwest Communications International
 - 1 Anita W. Lovely, Lovely Consulting, Inc., Consultant for Exxon Mobil Corporation
-

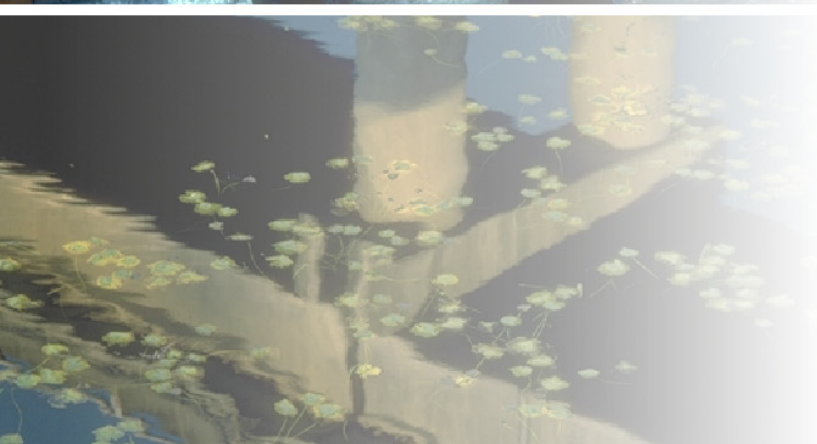

***Historical Shell/Niemi/Mobil
Petroleum Pipeline Investigation and
Decommissioning Report
Astoria Area Wide Petroleum Site
Astoria, Oregon***

***Prepared for
Shell Oil Company and
ExxonMobil Corporation***



HARTCROWSER

Delivering smarter solutions

www.hartcrowser.com

**Historical Shell/Niemi/Mobil Petroleum Pipeline Investigation
and Decommissioning Report
Astoria Area Wide Petroleum Site
Astoria, Oregon**

Anchorage

**Prepared for
Shell Oil Company and
ExxonMobil Corporation**

Denver

**July 30, 2004
15227-00**

Edmonds

Prepared by
Hart Crowser

Philadelphia



Portland

Leon Lahiere, R.G.
Associate

Seattle

CONTENTS

	<u>Page</u>
1.0 INTRODUCTION AND PURPOSE	1
2.0 BACKGROUND	1
<i>2.1 Historical Pipeline System Configuration and Use</i>	2
<i>2.2 Previous Pipeline System Investigation and Results</i>	2
3.0 PIPELINE INVESTIGATION AND DECOMMISSIONING ACTIVITIES	4
<i>3.1 Site Preparation Activities</i>	4
<i>3.2 Push Probe Explorations</i>	5
<i>3.3 Test Pit Excavations</i>	6
<i>3.4 Pipeline Inspections and Decommissioning Activities</i>	11
<i>3.5 Site Restoration Activities</i>	13
4.0 CHEMICAL ANALYSES AND RESULTS	14
<i>4.1 Analyses for Compounds of Concern</i>	14
<i>4.2 Analytical Results</i>	15
5.0 SUMMARY AND FINDINGS	16
6.0 REFERENCES	18

TABLES

1	Chemical Analysis Results Summary: Total Petroleum Hydrocarbons in Soil
2	Chemical Analysis Results Summary: BTEX in Soil
3	Chemical Analysis Results Summary: Polynuclear Aromatic Hydrocarbons (PAHs) in Soil

FIGURES

1	Site Location Map
2	Test Pit Excavation and Push Probe Locations
3	Test Pit Excavation Locations

CONTENTS (Continued)

**APPENDIX A
FIELD METHODS, EXPLORATION LOGS, AND DISPOSAL RECEIPTS**

**APPENDIX B
PHOTOGRAPHS**

**APPENDIX C
QUALITY ASSURANCE REVIEW AND ANALYTICAL LABORATORY
DOCUMENTATION**

HISTORICAL SHELL/NIEMI/MOBIL PETROLEUM PIPELINES INVESTIGATION AND DECOMMISSIONING REPORT ASTORIA AREA WIDE PETROLEUM SITE ASTORIA, OREGON

1.0 INTRODUCTION AND PURPOSE

This report documents the historical Shell Oil, Niemi Oil, and General Petroleum/ExxonMobil (Shell/Niemi/Mobil) petroleum pipeline system investigation and decommissioning activities conducted as part of the Astoria Area Wide Petroleum Site investigation (Figure 1). The purpose of these activities was to further assess soil conditions adjacent to the historical pipelines, evaluate the current condition of the remaining sections of the pipelines, and decommission the pipelines in place if warranted. The field activities were conducted from March 29 to April 5, 2004, and were performed in general accordance with the scope of work presented in the December 2003 Work Plan and the March 2004 Response to Oregon Department of Environmental Quality (DEQ) Comments letter (Hart Crowser, 2003 and 2004).

The pipeline investigation and decommissioning activities documented in this report were conducted with DEQ oversight under DEQ Unilateral Order No. ECSR-NWR-01-11 (Order) and are intended satisfy specific task requirements related to the historical Shell/Niemi/Mobil petroleum product pipelines pursuant to Attachment A, Sections III.5 and III.7 of the Order (DEQ, 2001). Although the requirement in the Order to investigate the historical pipelines is specific to Shell Oil Company (Shell) and Niemi Oil Company (Niemi), ExxonMobil voluntarily agreed to participate in the investigation and decommissionings as a result of its historical operations at the Port of Astoria (Port).

2.0 BACKGROUND

The current understanding of the configuration of the historical Shell/Niemi/Mobil pipeline system is based on information gleaned from the 1927 Port of Astoria Utility - Developments Map (1927 Map), historical aerial photographs, geophysical survey data, and several site inspections/visits (Port of Astoria, 1927 and EnviroLogic Resources, 2003). In general, the geophysical survey data corroborate the pipeline configuration shown on the 1927 Map. The pipeline configuration as shown on Figures 2 and 3 represents the best understanding of the historical Shell/Niemi/Mobil pipeline system. The sections of the pipeline system shown on the 1927 Map that were not verified by the geophysical survey or by this investigation are shown as dashed lines on the figures.

Additional site history and other background information is presented in the RI/FS and IRAM Development Work Plan (Phase 1 Work Plan) and subsequent documents related to the Astoria Area-Wide Petroleum Site investigation (EnviroLogic Resources, 2002 and 2003).

2.1 Historical Pipeline System Configuration and Use

Historical Offloading Pipelines Operated from the Mid 1920s to Early 1970s.

The historical petroleum product offloading pipelines are 6 inches in diameter. They were used from the mid 1920s to about 1972 to offload and transfer diesel and/or gasoline product from barges or ships docked at Pier 2/Slip1 to the Shell or Mobil (formerly General Petroleum Corp.) bulk plants. One 6-inch-diameter pipeline extends from the former offload point located on Pier 2 about 800 feet from the head of Slip 1 to a vault located about 50 feet east of the southeast corner of the existing Port office building (Figures 2 and 3). This portion of the pipeline was co-operated by Shell and Mobil to offload diesel and/or gasoline product from barges or ships docked at Pier 2/Slip1. The vault located southeast of the Port building was reportedly equipped with a "T" junction and gate valves that connected the single 6-inch-diameter offloading pipe to two separate 6-inch-diameter pipelines. One 6-inch-diameter pipeline extended southwest from the vault along Portway to the former Niemi/Mobil bulk plant and the other 6-inch-diameter pipeline extended northeast along Portway to the former Shell bulk plant (Figure 3). Opening one gate valve and closing the other gate valve routed offloaded product to either the former Niemi/Mobil bulk plant or the former Shell bulk plant. Another gate valve controlled the flow from the Pier 2 offloading pipeline.

Marine Filling Stations Operated from the Mid 1920s to 1950s. Shell operated a marine filling station located at the head of Slip 2 from about the mid 1920s to the mid 1950s. Diesel and/or gasoline product was transferred from the Shell Bulk plant to the filling dock by 3-inch-diameter pipeline(s). Mobil also operated a marine filling station in Slip 2 that was supplied by 3-inch-diameter pipeline(s) that extended from the Mobil bulk plant to the marine filling station. Based on historical aerial photographs and Sanborn maps, the marine filling stations ceased operations and filling equipment was removed from the docks in the mid to late 1950s. The approximate location of the historical marine filling stations and product supply pipelines are shown on Figure 3.

2.2 Previous Pipeline System Investigations and Results

Geophysical Surveys Conducted in 2002. Geophysical surveys were performed at the site in the fall of 2002 to identify or verify and mark the location and extent of the historical petroleum pipeline network at the site (EnviroLogic

Resources, 2003). The traces of the pipeline network shown on the 1927 Map and identified by the survey are shown as solid lines on Figures 2 and 3. The survey suggested that portions of the pipelines have been removed from the site (indicated by dashed lines on Figures 2 and 3). Specifically, the survey suggests that portions of the 6-inch-diameter pipeline beneath Pier 2 have been removed (see discussion below), the 3-inch-diameter pipelines that supplied the historical marine filling docks could not be traced northwest of the Port's Maintenance building (suggesting the 3-inch-diameter pipelines have been removed from this area), and the Shell portion of the 6-inch-diameter pipeline and the two 3-inch-diameter pipelines appear to terminate beneath the middle of Portway prior to entering the former Shell bulk plant.

Shell Conducted Limited Pipeline Inspection in 2002. The central axis of Pier 2 landward of Outfall No. 4 is underlain by fill and the remainder of Pier 2 is supported on pilings. The 1927 Map indicates the single 6-inch-diameter historical Shell/Mobil bulk product offloading pipeline on Pier 2 is within (but near the top of the slope of) the filled area. The entire pier northwest (seaward) of Outfall No. 4 is exposed and supported by pilings.

In October 2002, Hart Crowser reviewed historical site plans, the geophysical survey data, and conducted a site inspection to identify and inspect the historical pipelines where accessible. A metal hatch on Pier 2 located near Outfall No. 4 allowed access beneath the pier in this area and a 6-inch-diameter steel pipe was observed beneath Pier 2 running parallel to Slip 1 about 50 feet landward of Outfall No. 4. The pipe was attached to the bottom of the pier dock with metal brackets. Inspection of the pipeline in both directions from the access point was conducted, and Hart Crowser observed that the pipeline was truncated about 25 feet from the access point in each direction (i.e., the length of remaining piping in this area is about 50 feet). Product or product residue was not observed in the truncated section of pipe. Staining or product residue was not observed beneath the exposed section of pipe. Another access hatch on Pier 2 located about 100 feet seaward of Outfall No. 4, near the receiving terminus of the historical product pipeline, allowed access beneath Pier 2 in this area. There were no remaining sections of the 6-inch-diameter pipe in the area seaward of Outfall No. 4 near the historical terminus of the pipeline.

The bank at the end of Slip 2 in the area of the historical marine filling station dock was also inspected in 2002 for evidence of petroleum pipelines. Two large (10- to 12-inch-diameter) corrugated steel pipes were noted along the bank at the termini locations (as shown on the 1927 Map) of the historical 3-inch-diameter marine filling station product supply pipelines. Petroleum pipelines are not constructed using corrugated piping; however, the observed corrugated piping may have served as chases for the historical product pipelines. Product

or product residue were not observed in the corrugated pipes. Attempts to trace these pipes landward using a magnetic induction locator were not successful (the geophysical survey contractor also attempted to trace these pipes using magnetic and ground penetrating radar equipment without success). No other indications of the presence of pipelines were observed in the historical marine filling docks area.

3.0 PIPELINE INVESTIGATION AND DECOMMISSIONING ACTIVITIES

The historical pipeline investigation and decommissioning activities were conducted from March 29 to April 5, 2004. The activities included site preparation tasks, completing test pit and push probe explorations, collecting soil samples for chemical analyses, inspecting and decommissioning the pipelines in place, and restoring the test pit exploration areas to pre-investigation conditions. Hart Crowser oversaw and documented all site activities. Terra Hydr, under direct contract to Shell, completed the test pit explorations, pipeline decommissioning, and site restoration activities; and Geo-Tech Explorations, Inc., under direct contract to the Astoria Area Wide Potentially Responsible Parties Group (PRP Group), completed the push probe explorations. EnviroLogic Resources, Inc., and URS Corp. conducted additional oversight on behalf of the PRP Group and ExxonMobil, respectively.

The exploration locations are shown on Figures 2 and 3. Push probe and test pit exploration logs and a description of field and sampling procedures are included in Appendix A of this report. Additional details are presented in Appendices A and E of the Phase I Work Plan (EnviroLogic Resources, 2002). Appendix B of this report contains representative photographs of the field activities. A quality assurance (QA) review and analytical laboratory documentation are presented in Appendix C of this report. Analytical laboratory results are summarized in Tables 1 through 3.

3.1 Site Preparation Activities

Health and Safety Plan. We prepared a site-specific Health and Safety Plan (HSP) in general accordance with the Occupational Safety and Health Act (OSHA) and the Oregon Administrative Rules (OAR). The HSP was reviewed and signed by field personnel prior to initiating the field activities.

Utilities. Hart Crowser contacted the Oregon Utility Notification Center, who in turn notified the various utilities in the area to mark any underground installations in the vicinity of the site. In addition, Locates Down Under, Inc., under

subcontract to Hart Crowser, marked metallic underground utilities in the area of the planned explorations.

3.2 Push Probe Explorations

Five push probe explorations (designated SB-915(S) through SB-919(S)) were completed at the locations shown on Figure 2 on March 31, 2004. The purpose of these explorations was to assess soil conditions beneath and adjacent to the historical Shell/Niemi/Mobil Pier 2 product offloading and marine filling station supply pipelines. The depth of the historical pipelines was estimated to be about 3 to 5 feet below ground surface (bgs). All explorations were advanced to a depth of 6 feet bgs to evaluate soil conditions adjacent to and below the likely depth of the pipelines. The explorations were completed using a truck-mounted push probe drilling rig following procedures described in Appendix A. Exploration logs are included in Appendix A, as Figures A-2 through A-6. Figure A-1 provides an explanation of soil descriptions and symbols used on the logs.

Push Probe Locations. Three push probe explorations were completed along the trace of the historical 6-inch-diameter product off-loading pipeline: exploration SB-915(S) was located near the terminus of the land portion of Pier 2 about 100 feet landward of Outfall No. 4; exploration SB-918(S) was located about 200 feet landward (southeast) of exploration SB-915(S); and exploration SB-919(S) was located about 50 feet north of the Port office, about equidistant from test pit explorations EX-1 and EX-2. Explorations SB-916(S) and SB-917(S) were completed west of the Port Maintenance building in the area of the former 3-inch-diameter product pipelines that supplied the historical marine filling stations.

Push Probe Sampling. Continuous soil samples were collected from each exploration. Soils encountered generally consisted of dark gray to brown silty sands. Concrete rubble and burned wood debris were present at the SB-916(S) location from 1 to 2 feet bgs. The push probe encountered refusal at 1 foot bgs at the original SB-916(S) location. The location was moved about 5 feet northwest (along the suspected trace of the former pipeline). Concrete rubble was encountered at this location at 1 to 2 feet bgs; however, the probe was able to penetrate the rubble and exploration SB-916(S) was completed to 6 feet bgs.

Groundwater was encountered in explorations SB-916(S) and SB-917(S) at depths of 5 feet and 3 feet bgs, respectively. Site monitoring well data in the area indicate the top of groundwater in this area is typically greater than 6 feet bgs, suggesting the groundwater encountered in these explorations was likely localized perched water lenses and not the area wide shallow groundwater aquifer. Groundwater samples were not collected from the explorations.

One soil sample from each exploration, collected from 5 to 6 feet bgs, was submitted to North Creek Analytical (NCA) in Beaverton, Oregon, for chemical analyses. All samples were placed into labeled, laboratory-supplied containers and handled using procedures described in Appendix A. Chain of Custody was maintained and documented throughout the sample management process.

Field Screening. All soil samples were visually inspected for petroleum hydrocarbon staining and field screened for volatile petroleum hydrocarbon compounds using a photoionization detector (PID) and for non-volatile petroleum hydrocarbons using a sheen test. There were no field indications suggesting the presence of petroleum hydrocarbons in the push probe samples.

Push Probe Exploration Abandonments. All explorations were abandoned in general accordance with Oregon Water Resources Department (OWRD) regulations and procedures after the sampling activities were completed. The abandonment procedure consisted of filling the exploration with granular bentonite and hydrating the bentonite.

3.3 Test Pit Excavations

From March 29 to April 1, 2004, four test pit excavations (designated EX-1 through EX-4) were completed as part of this investigation. The purpose of these excavations was to expose the historical petroleum pipelines at likely junctions, elbows, and suspected current inland termini; assess soil conditions and the condition of the pipelines at these points; and decommission the pipelines in place by grout sealing if not previously decommissioned.

Excavation Locations. The four test pit excavations were completed at the locations shown on Figures 2 and 3. Test pit EX-1 was completed at the "T" gate valve junction vault of the historical 6-inch-diameter offloading pipeline from Pier 2 and the two 6-inch-diameter pipelines that formerly transferred product from the Pier 2 offloading pipeline to the former Shell and Niemi/Mobil bulk plants. Test pit EX-2 was located within Portway in front of the former Niemi/Mobil bulk plant near the anticipated terminus of the 6-inch-diameter Niemi/Mobil pipeline. Test pit EX-3 was located at the current terminus (based on geophysical survey data) of the Shell pipelines within Portway in front of the former Shell bulk plant (currently occupied by the Oregon State Police Astoria Office). Test pit EX-4 was located along the historical offloading pipeline at an elbow joint located on the land portion of Pier 2 about 400 feet northwest of Portway, about equidistant between push probe explorations SB-918(S) and SB-919(S). A fifth test pit was originally proposed along the historical Mobil 3-inch-diameter marine station supply pipeline at an elbow joint (based on the 1927 Map) located south of the Port Maintenance building. However, the

geophysical survey and recent utility locate survey did not locate any pipelines in this area and based on the lack of geophysical anomalies in this area, a test pit was not completed at that location.

Excavation and Soil Handling Procedures. All excavations were completed by mechanical excavation and hand digging to depths ranging from 4 to 6 feet using procedures described in Appendix A. Excavated material from excavations EX-1, EX-3, and EX-4 was placed on the asphalt concrete surface adjacent to each respective excavation location. Soil from EX-2 exhibited a slight weathered petroleum-like odor at the time of excavation but did not exhibit indications of visible residual product. This soil was spread out on plastic sheeting to aerate until the excavation and pipeline decommissioning activities were completed and the site was restored.

A Hart Crowser representative was present to observe and document the test pit exploration activities. Exploration logs showing cross-sectional and plan views of each test pit are included in Appendix A, as Figures A-7 through A-10. The pipeline configurations, soil type and condition, and other observations encountered in each excavation are discussed below.

3.3.1 Test Pit Excavation EX-1

Test pit excavation EX-1 was completed at the "T" gate valve junction of the historical 6-inch-diameter offloading pipeline from Pier 2 and the two 6-inch-diameter pipelines that were used to transfer product from the Pier 2 pipeline to the former Shell and Niemi/Mobil bulk plants (Figures 2 and 3). The dimensions of the excavation were 8 feet by 10-1/2 feet with a maximum depth of 5 feet. A 6-foot by 6-foot by 4-foot open bottom concrete vault containing the subject petroleum piping and valves was encountered in the excavation (Photograph 1). Figure A-7 presents cross-sectional and plan views of the excavation showing the dimensions of the vault and the piping configuration described below.

Piping Configuration. The 6-inch-diameter offloading pipeline from Pier 2 equipped with an upright gate valve enters the base of the northern side of the vault at a depth of 4 feet bgs. The gate valve is connected to a short (3-1/2-foot) section of pipe with an exposed upright T-flange, that in turn is connected to a damaged gate valve (Photographs 2 and 3). Both valves appear to be in the "closed" position. A 6-inch-diameter pipe is connected to the southern flange of the damaged gate valve and exits the vault to the south. A metal tag labeled "Mobil" was attached to this flange, indicating this pipe (at 4 feet bgs) was used to transfer product to the former Niemi/Mobil bulk plant. A second 6-inch-diameter pipe (i.e., the pipeline used to transfer product from the off-loading pipeline to the former Shell bulk plant) with a bolted steel end cap extends into the vault from the

south at a depth of 2-1/2 feet bgs about 1-1/2 feet (Photographs 2 and 3). The configuration of this pipe and the exposed T-flange suggest when the pipeline system was operational a third gate valve and section of pipe completed the connection between the lower product off-loading pipeline and the upper Shell supply pipeline. This removed section and the presence of the end cap on the Shell pipeline suggest the system was rendered inoperable when offloading operations ceased in the early 1970s. The pipeline exteriors are coated with a thin layer of rust; however, no holes or pitting were observed in the exposed piping; and the end plate and all existing fittings and flanges were tight with no indications (e.g., staining, product seeps from joints and fittings, presence of petroleum-like tar, etc.) of historical releases.

Other features present in the EX-1 excavation include high-voltage power lines, encased in concrete, situated directly above the vault (Photographs 1 and 2). Other "non-petroleum" piping is located adjacent to the concrete vault. The 6-inch-diameter water main running parallel to Portway is located immediately south of the vault (3-1/2 feet bgs). A 4-inch pipe of unknown purpose is directly east of the vault. A third pipe, a cut-off abandoned 3-inch-diameter line of unknown historical use, is present in the excavation at 2 feet bgs about 2 feet south of the vault.

Soil Conditions and Sampling. Soils encountered in EX-1, beneath asphalt concrete and base gravel, generally consist of gray to brown sand fill. The concrete vault was filled with sand, gravel, and concrete rubble (Photograph 3). Several tar-like balls were encountered in the sand fill south of the vault adjacent to the water line. The extent of the tar balls was very limited and no tar-like substances were encountered within the vault or adjacent to the exposed petroleum pipelines. Petroleum-like odors, staining, or residual diesel or gasoline product were not observed in the excavation. Sample EX-1/S-1 was collected from the base of the excavation (5 feet bgs) beneath the open T-flange of the 6-inch-diameter petroleum pipe (Figure A-7). Field screening (PID and sheen test) did not suggest the presence of petroleum hydrocarbons in the excavation soils.

3.3.2 Test Pit Excavation EX-2

Test pit excavation EX-2 was located within Portway north of the former Niemi/Mobil bulk plant near the anticipated point the 6-inch-diameter Niemi/Mobil product supply pipeline enters the former Niemi/Mobil bulk plant and the point (based on the 1927 Map) the 3-inch-diameter product supply pipeline(s) from the former Shell bulk plant branch west (seaward) toward the former marine filling station (Figure 3). The dimensions of the initial excavation were 5 feet by 13-1/2 feet by 4 feet deep. A small excavation was also completed 5 feet east of the initial excavation in an attempt to locate the former

Shell marine filling station supply lines at the locations shown on the 1927 Map. Figure A-8 presents cross-sectional and plan views of the excavations showing the piping configuration described below.

Piping Configuration. The 6-inch-diameter former Niemi/Mobil bulk plant product supply pipeline enters the excavation from the northeast at a depth of 2-1/2 feet bgs, bends 90° (southeast in the direction of the former bulk plant) and exits the excavation (Photograph 4). The exposed section of pipe is solid (no joints or unions) and the exterior is in excellent condition with only minor rust and no pitting, holes, or product seeps were observed. No other pipelines (including the former Shell marine filling station product supply lines shown on the 1927 Map at this location) were encountered in either excavation at the EX-2 location.

Soil Conditions and Sampling. Soils encountered in EX-2, beneath asphalt concrete and base gravel, consist of well-sorted gray sand fill. The sand fill exhibited a uniform gray petroleum-like stain and odor throughout the depth and lateral extent of the excavation (Photograph 4). Residual product was not encountered in the excavation. Sample EX-2/S-1 was collected from beneath the pipeline at a depth of 4 feet bgs and sample EX-2/S-2 was collected from the wall of the excavation above the pipeline (Figure A-8). The PID value for sample EX-2/S-1 was 75 and the PID value for EX2/S-2 was 60. Sheen testing results were negative for both samples. The uniformity of staining, odor, and PID values throughout the exposed sand fill (above and below the pipeline), the absence of residual product, and the condition of the petroleum pipe at the EX-2 excavation location suggest the staining and odor present in the sand fill are not the result of historical releases from the former Niemi/Mobil bulk plant product supply pipeline.

3.3.3 Test Pit Excavation EX-3

Test pit excavation EX-3 was located within Portway northwest of the former Shell Bulk Plant (Figure 3). The dimensions of the excavation were 4-1/2 feet by 8-1/2 feet by 3-1/2 feet deep. Figure A-9 presents cross-sectional and plan views of the excavations showing the piping configuration described below.

Piping Configuration. The 6-inch-diameter former Shell bulk plant product supply pipeline enters the excavation from the northwest at a depth of 2-1/4 feet bgs and is connected with a 90° elbow joint to another 6-inch-diameter section of pipe that enters the excavation from the southeast. A 3-inch-diameter pipeline (assumed to be the product supply line for the marine filling station) is positioned adjacent to the 6-inch-diameter pipe and is also connected with a 90° elbow joint to another 3-inch-diameter section of pipe that enters the excavation from the southeast

(Photographs 5 and 6). A second 3-inch-diameter pipeline is shown on the 1927 Map at this location; however only one 3-inch-diameter pipeline was encountered in the excavation. Wood planks underlay both pipes and two abandoned (cut off) steel electrical conduits were present in the excavation. The exteriors of the exposed pipelines are coated with a thin layer of rust; however, no pitting or holes were observed in the exposed piping and the elbow flanges were tight with no indications (e.g., staining, product seeps from joints and fittings, presence of petroleum-like tar, etc.) of historical releases.

Soil Conditions and Sampling. Soils encountered in EX-3, beneath asphalt concrete and base gravel, generally consist of brown slightly gravelly sand fill (Photograph 6). Residual product, petroleum-like odors, or staining were not observed in the excavation. Field screening (PID and sheen test) did not suggest the presence of petroleum hydrocarbons in these soils. Sample EX-3/S-1 was collected beneath the 90° elbow pipe joints at 3 feet bgs (Figure A-9).

3.3.4 Test Pit Excavation EX-4

Test pit excavation EX-4 was located along the historical offloading pipeline at an elbow joint located on the land portion of Pier 2 about 400 feet northwest of Portway, about equidistant between push probe explorations SB-918(S) and SB-919(S) (Figure 2). The dimensions of the excavation were 5 feet by 5 feet by 6 feet by 6 feet deep. Figure A-10 presents cross-sectional and plan views of the excavations showing the piping configuration described below.

Piping Configuration. The 6-inch-diameter product off-loading pipeline from Pier 2 is encountered in the excavation at a depth of 4 feet bgs. The exposed section of pipe has a slight bend (about 10°) but no joints or fittings were encountered in the excavation (Photograph 7). A thin layer of rust coats the pipeline, but no holes or pitting were observed and there are no staining, product seeps, or other indications of petroleum releases in this area.

Soil Conditions and Sampling. Soils encountered in EX-4, beneath asphalt concrete and base gravel, consist of about 1 foot of gray gravel and cobbles underlain with brown sand fill. Concrete was encountered on the northwest wall of the excavation from 2 to 3-1/2 feet bgs (Photograph 7). Residual product, petroleum-like odors, or staining were not noted in exposed excavation soils. Field screening (PID and sheen test) did not suggest the presence of petroleum hydrocarbons in these soils. Sample EX-4/S-1 was collected beneath the pipeline at 5 feet bgs (Figure A-10).

3.4 Pipeline Inspections and Decommissioning Activities

3.4.1 Historical Pipeline Decommissioning

The exposed pipelines at each excavation location were inspected for indications of historical releases and historical abandonment/decommissioning activities. Indications of prior pipeline abandonment/decommissioning were observed in Excavation EX-1 and are described below. There were no indications of historical pipeline decommissioning activities (e.g., pipelines cut and capped, lines grouted in place, etc.) on the exposed pipeline sections encountered in excavations EX-2, EX-3, or EX-4.

The exposed section of petroleum piping in Excavation EX-1 consisted of the 6-inch-diameter off-loading pipeline from Pier 2 connected to an upright gate valve, connected a 3-1/2-foot section of 6-inch-diameter pipe with an exposed upright T-flange, connected to a damaged gate valve that connected to the 6-inch-diameter Niemi/Mobil bulk plant product transfer pipe (Photographs 1 and 2). Both gate valves were in the closed position. The exposed section of the 6-inch-diameter pipe used to transfer product to the Shell bulk plant was sealed with a steel cap bolted onto the end of the pipe (Photograph 3).

The existing piping configuration at the EX-1 location suggest when the pipeline system was operational a third gate valve and section of pipe completed the connection between exposed T-flange and the Shell bulk plant supply pipeline (Photograph 2). The missing section of piping and the presence of the end cap on the former Shell pipeline suggest the former Shell/Niemi/Mobil pipeline system was decommissioned in place when off-loading operations ceased in the early 1970s by draining the lines and rendering the pipeline system inoperable by removing the Shell bulk plant gate valve and capping the Shell line, closing the gate valves on the off-loading and Niemi/Mobil lines, and filling in the concrete vault with gravel and concrete rubble.

3.4.2 2004 In Place Decommissioning Activities

The in place decommissioning activities were conducted from March 30 to April 1, 2004. The decommissioning process generally consisted of drilling a 1/2-inch-diameter hole (cold tap) in the top of the exposed pipe, a rod was then lowered into the pipe to determine if any liquid (product and/or water) was present, and PID and combustible gas probes were placed in the opening to assess the presence of volatile compounds and combustible gases (in percent of lower explosion limit [LEL]). Sorbent pads and a bucket were placed beneath each line prior to tapping to contain and prevent the discharge of product, if present, to the underlying soils. If LEL readings were acceptable (less than

10 percent), a 2-inch-diameter hole was saw cut into the top of the pipe to allow inspection of the inside of the pipe, to remove any residual liquid, and to access the pipe for in place grouting. The inside condition of the pipe was noted. Groundwater (with no sheen or odor), if present, was allowed to drain from the pipe or if oily water/residual product was present, this liquid was removed from the pipe using a vacuum truck.

The exposed pipeline sections were decommissioned in place using quick setting Portland cement based grout. The grout was poured into the pipe opening until the opening overflowed. The pipeline was tapped with a hammer to facilitate the removal of air pockets and the grout was allowed to settle. The filling and tapping/settling process was repeated several times until grout settlement ceased and the pipe was completely full at the access opening and would no longer accept additional grout.

The condition of and the specific decommissioning activities for each exposed pipeline section are further described below.

EX-1 Location. The petroleum pipeline exteriors at this location were coated with a thin layer of rust; however, no holes or pitting were observed in the exposed piping; and the end plate and all existing fittings and flanges were tight (except for the open T-flange) with no petroleum-like staining or seeps around the exposed pipe joints and fittings. The former Shell and Niemi/Mobil product supply pipelines were drilled as described above. Residual product and/or water were not present in the lines and LEL/PID readings were non-detect. The exposed upright T-flange (Photograph 2) was sealed with about 2 gallons (~1/4 cubic feet [ft³]) of grout. The drilled holes in the former Shell and Niemi/Mobil product supply pipelines were left open until pipeline inspection and decommissioning activities were completed at the EX-2 and EX-3 locations so air was able to enter the lines (during groundwater and oily water removal) and to allow venting as grout seals were installed in the pipelines at the EX-2 and EX-3 locations. Following grout placement at the EX-2 and EX-3 locations, the concrete vault was filled with Portland cement concrete (see Section 3.5) to further encase and seal the historical pipelines at this location.

EX-2 Location. The exposed section of the 6-inch-diameter former Niemi/Mobil bulk plant product supply pipeline at this location is solid (no joints or unions) and the exterior exhibited no signs of rust, pitting or indications of historical releases. A hole was drilled in the top of the pipe and the pipe was completely filled with water. The water did not have a sheen or odor, a vertical saw cut was completed, and the water drained from the pipe into the excavation (Photograph 8). Two, 2-inch-diameter access holes were cut into the top of the pipe on either side of the saw cut (Figure A-8). LEL/PID readings from the

interior of the pipe were non detect and residual product was not observed in the openings. About 25 gallons (~4-1/3 ft³) of grout were poured into the two access holes to seal this pipeline section (Photographs 9 and 10).

EX-3 Location. The exposed 6-inch-diameter and 3-inch-diameter pipeline exteriors were coated with rust; however, no holes or pitting were observed in the exposed piping and the elbow flanges were tight with no indications (e.g., staining, presence of petroleum-like tar, etc.) of historical releases (Photographs 5 and 6). A hole was drilled into each pipe. Less than an inch of water with no product, sheen, or odor was present in the 3-inch-diameter line and LEL/PID readings from the 3-inch-diameter line were non-detect. About 4-1/2 inches of water with a strong petroleum-like odor and globules of residual product were encountered in the 6-inch-diameter line. Vapors present in the 6-inch-diameter line yielded a PID reading of 590 and a combustible gas reading of about 5 percent LEL (Photograph 11). Two-inch access holes were cold cut in the top of each pipe to facilitate liquid removal and subsequent grouting (Photograph 12).

The water and emulsified product were removed from each pipeline to the extent practicable using a vacuum truck. Less than 10 gallons of water were removed from the 3-inch-diameter line. About 290 gallons of water and emulsified product and globules were removed from the 6-inch-diameter pipeline (Photograph 13). A copy of the water/product disposal receipt is included in Appendix A.

Each pipe was filled with grout following the water/product removal activities to seal these sections of piping. About 4 gallons (~1/2 ft³) of grout were placed in the 3-inch-diameter pipe and about 8 gallons (~1 ft³) of grout were placed in the 6-inch-diameter pipe using procedures described above.

EX-4 Location. The exposed section of the historical 6-inch-diameter product off-loading pipeline was coated with a thin layer of rust, but no holes or pitting were observed in the pipe and staining or other indications of releases were not present at this location (Photograph 7). A hole was drilled in the top of the pipe and the pipe was probed for the presence of liquid. Water and/or product were not present in the pipe. LEL/PID readings from the interior of the pipe were non detect. A 2-inch-diameter access hole was cut in the top of each pipe; residual product was not observed in the pipe opening. About 15 gallons (2 ft³) of grout were placed in the 6-inch-diameter pipe using procedures described above.

3.5 Site Restoration Activities

The excavations were abandoned and the disturbed areas restored following the test pit description, soil sampling, and pipeline decommissioning activities.

Excavations EX-3 and EX-4 were backfilled in reverse order (last out, first in) with the stockpiled excavated soil. After two days of aeration the soil from EX-2 did not exhibit a petroleum-like odor or yield a detectable PID reading, and the soil was returned to the EX-2 excavation. All three excavations were backfilled to within 6 inches of surrounding grade and compacted in 2-foot lifts to a non-yielding state using a vibratory compactor (Photograph 14).

Excavated soil was not returned to the concrete vault in Excavation EX-1 because the configuration of the high-voltage power lines and multiple pipes within the concrete vault restricted soil placement and adequate compaction. To ensure subsequent settlement would not occur (and to encase and seal the pipelines and fittings and valves within the vault), the concrete vault was completely filled with Portland cement concrete (Photographs 15 and 16). Concrete was also placed in the remaining excavation up to the top of the exposed pipes (about 2 feet bgs). Excavated soil was then placed in the EX-1 excavation to within 6 inches of surrounding grade and compacted to a non-yielding state using a vibratory compactor.

The surface restoration for all excavations consisted of three inches of compacted crushed gravel capped with three inches of asphalt concrete. The site restoration activities were completed by April 5, 2004.

4.0 CHEMICAL ANALYSES AND RESULTS

4.1 Analyses for Compounds of Concern

At least one sample from each push probe and test pit location, based on field observations and screening and to provide a range of coverage, was submitted to NCA for chemical analyses. Qualitative analyses for total petroleum hydrocarbon (TPH) identification by Northwest TPH Methodology NWTPH-HCID and/or quantitative analyses for gasoline and diesel/heavy oil range petroleum hydrocarbons by Northwest Methods NWTPH-Gx, and NWTPH-Dx, respectively, were performed on all submitted samples. Samples with detectable concentrations of diesel and heavy oil range TPH (as TPH-Dx) also were analyzed for benzene, toluene, ethylbenzene, and total xylenes (BTEX) by EPA Method 8021B and polynuclear aromatic hydrocarbons (PAHs) by EPA Method 8270-SIM.

The analytical results are summarized in Tables 1 through 3. A QA review was completed and the analytical data are suitable for the purposes of this project. The QA review and analytical laboratory documentation are presented in Appendix C of this report.

4.2 Analytical Results

Total Petroleum Hydrocarbon Identification. TPH-HCID analyses were performed on samples SB-915(S)-5.0, SB-916(S)-5.0, SB-917(S)-5.0, SB-918(S)-5.0, SB-919(S)-5.0, and EX-4/S-1 (Table 1). Gasoline and diesel range petroleum hydrocarbons were not present in the samples at or above the method reporting limit. Heavy oil range TPH was detected in sample SB-915(S)-5.0 only.

Gasoline Range Petroleum Hydrocarbons. Samples EX-1/S-1, EX-2/S-1, EX-2/S-2, and EX-3/S-1 were analyzed for gasoline range (C_7 - C_{12}) petroleum hydrocarbons (Table 1). Gasoline range petroleum hydrocarbons were not present at or above the method report limit in the samples.

Diesel and Heavy Oil Range Petroleum Hydrocarbons. Samples SB-915(S)-5.0, EX-1/S-1, EX-2/S-1, EX-2/S-2, and EX-3/S-1 were analyzed for diesel (C_{10} - C_{28}) and heavy oil ($>C_{28}$) petroleum hydrocarbons (Table 1). Diesel range petroleum hydrocarbons were present in samples EX-1/S-1 and EX-3/S-1 at concentrations of 26.5 milligrams per kilogram (mg/kg) and 770 mg/kg, respectively. Heavy oil range petroleum hydrocarbons were present in samples SB-915(S)-5.0 (294 mg/kg), EX-2/S-1 (110 mg/kg), and EX-3/S-1 (760 mg/kg). Notes included with the laboratory documentation stated the chromatogram for sample EX-1/S-1 is not a distinct diesel pattern and may represent heavily weathered diesel or biogenic interference. The chromatogram for sample EX-3/S-1 has distinct peaks suggesting the presence of PAHs and additional peaks that may be due to biogenic interference.

Benzene, Toluene, Ethylbenzene, and Total Xylenes. Samples EX-1/S-1, EX-2/S-1, EX-3/S-1, and EX-4/S-1 were analyzed for BTEX compounds (Table 2). Benzene was not present in the samples at or above the method reporting limit. Toluene, ethylbenzene, and total xylenes were present in sample EX-2/S-1 at low concentrations (total less than 0.3 mg/kg). BTEX were not present at or above the method reporting limit in samples EX-1/S-1, EX-3/S-1, and EX-4/S-1.

Polynuclear Aromatic Hydrocarbons. Samples SB-915(S)-5.0, EX-1/S-1, EX-2/S-1, EX-3/S-1, and EX-4/S-1 were analyzed for PAHs (Table 3). Several carcinogenic PAHs were present in sample EX-3/S-1: benzo(a)anthracene (0.0967 mg/kg), chrysene (0.106 mg/kg), benzo(b)fluoranthene (0.0941 mg/kg), and benzo(a) pyrene (0.102 mg/kg). Several non-carcinogenic PAHs were present in samples EX-2/S-1 and EX-3/S-1 at concentrations not exceeding 0.2 mg/kg. PAHs were not present at or above the method reporting limit in samples SB-915(S)-5.0, EX-1/S-1, and EX-4/S-1.

5.0 SUMMARY AND FINDINGS

Purpose. Soil investigation and pipeline inspection and decommissioning activities related to historical Shell/Mobil/Niemi petroleum pipeline operations were conducted from March 29 to April 5, 2004, as part of the Astoria Area Wide Petroleum Remedial Investigation. The purpose of these activities was to further assess soil conditions adjacent to the historical pipelines, evaluate the current condition of the pipeline system, and decommission the pipelines in place. The activities were conducted with DEQ oversight under the terms of the Order and are intended to satisfy task requirements of the Order specific to Shell and Niemi.

Field Activities. Push probe and test pit explorations were completed and soil samples were collected and analyzed for petroleum hydrocarbons and selected constituents. The configuration and condition of the pipelines exposed in the test pits were observed and documented. The exposed pipes were inspected for rust, pits, holes, or other indications of historical releases. Access holes were cut in the pipelines, inspected for the presence of water and/or product, and screened for combustible vapors. About 300 gallons of water and emulsified water/residual product were removed from the former Shell bulk plant supply line and transported to a licensed facility for recycling. The exposed pipeline sections were sealed with Portland cement grout after sampling, and inspection activities were completed and the disturbed areas were restored to a pre-investigation condition.

Analytical Results. Diesel and heavy oil range petroleum hydrocarbons and PAHs were present in several samples at concentrations that are not indicative of significant historical petroleum releases. Toluene, ethylbenzene, and total xylenes were present at low concentrations (less than 0.2 mg/kg) in the sample from EX-2; however, the uniform odor and staining observed in the soils above and below the pipeline exposed in EX-2 suggest the presence of these compounds is likely related to the sand fill material and not a result of historical pipeline activities or releases.

Condition of Pipelines. The inspection activities indicate the historical Shell/Mobil/Niemi petroleum pipeline system is in excellent condition. No holes or pitting were observed in the pipes and, except for a thin layer of rust, the exposed pipe sections did not exhibit signs of corrosion or weathering. All exposed joints and fittings were tight with no petroleum-like staining or product seeps. Small globules of residual product mixed with water were present in the former Shell bulk plant product supply pipeline. The former Niemi/Mobil bulk plant product supply pipeline contained water with no odor or sheen. Free

phase petroleum product was not encountered in any of the inspected pipelines and residual product was not present in the excavations.

No Indications of Historical Pipeline Releases Observed in Explorations. The overall condition of the pipelines observed in the excavations, the lack of significant residual product remaining in the pipelines, the absence of residual product or staining in the excavations or soil samples, and the analytical results combine to suggest it is highly unlikely petroleum releases have occurred from the historical Shell/Niemi/Mobil petroleum pipeline system. The observed current pipeline configuration at the EX-1 location (end cap bolted to the Shell bulk plant supply pipeline, closed gate valves, a removed section of piping and fittings, and no product encountered in the pipelines) indicates the pipeline system was likely drained and rendered inoperable when operations ceased in the early 1970s. The concrete encasement of the pipelines at the EX-1 location and the placement of grout plugs in the pipelines at the other test pit locations will further prevent future pipeline use or the potential for unintended migration of liquids within the pipelines.

Historical Marine Filling Station Pipelines Status. The 1927 Map showed two 3-inch-diameter product lines extending from the former Shell bulk plant to the historical marine filling station in Slip 2 (paralleling the 6-inch-diameter bulk plant product supply line along Portway). Only one 3-inch-diameter product line was encountered in test pit EX-3, suggesting the 1927 Map is inaccurate and the Shell marine filling station was supplied by only one 3-inch-diameter pipeline. In addition, the 1927 Map indicated the Shell 3-inch-diameter product lines would have been present at the EX-2 location; however, no 3-inch-diameter product lines were encountered at that location.

The geophysical survey and underground locating conducted prior to this investigation did not identify any pipelines west (seaward) of the Port maintenance building, suggesting the historical 3-inch-diameter marine filling station product supply pipelines have been removed from this area. Petroleum hydrocarbons were not present in soil samples from the two push probes (SB-916(S) and SB-917(S)) completed near the likely termini of the historical marine filling station supply lines, suggesting no historical petroleum pipeline releases in this area.

The geophysical survey and underground locating conducted prior to this investigation identified two metallic anomalies south-east of the Port maintenance building that likely represent remaining sections of the historical marine filling station supply pipelines (shown as solid lines on Figures 2 and 3). Each anomaly is about 50 feet long and terminates before entering Portway. The truncation of these anomalies (and no geophysical anomalies seaward of the

maintenance building) suggests large sections of the historical marine filling station supply pipelines have been removed and are no longer intact in this area.

6.0 REFERENCES

EnviroLogic Resources, 2002. RI/FS and IRAM Development Work Plan, Phase 1, Remedial Investigation/Feasibility Study, Astoria Area-Wide Petroleum Site, Astoria, Oregon. July 15, 2002.

EnviroLogic Resources, 2003. Technical Memorandum, Geophysical Survey, Astoria Area-Wide Petroleum Site, Astoria, Oregon. November 25, 2003.

Hart Crowser, 2003. Historical Shell/Niemi/Mobil Petroleum Pipelines Investigation and Decommissioning Work Plan, Addendum to RI/FS and IRAM Development Work Plan Phase 1, Astoria Area Wide Petroleum Site, Astoria, Oregon. December 18, 2003.

Hart Crowser, 2004. Response to DEQ Comments, Remedial Investigation/Feasibility Study (RI/FS) Work Plan Addendum, Historical Shell/Niemi/Mobil Petroleum Pipelines Investigation and Decommissioning Work Plan, Astoria Area Wide Petroleum Site, Astoria, Oregon. March 1, 2003.

Oregon Department of Environmental Quality (DEQ), 2001. DEQ No. ECSR-NWR-01-11: Order Requiring Remedial Investigation, Feasibility Study, and Interim Removal Action Measures, Port of Astoria, et al. December 5, 2001.

Port of Astoria, 1927. Map of Utility Developments, Port of Astoria Terminal. January 1927.

**Table 1 - Chemical Analysis Results Summary: Total Petroleum Hydrocarbons in Soil
Historical Shell/Niemi/Mobil Pipeline Investigation
Astoria Area Wide Petroleum Site, Astoria, Oregon**

Sample Identification	Sampling Date	Sampling Depth in Feet	Field PID	Oil Sheen	Concentrations in Milligrams per Kilogram (mg/kg)					
					TPH-HCID			TPH-Gx	TPH-Dx	
					Gasoline	Diesel	Heavy Oil	(C ₇ -C ₁₂)	(C ₁₀ -C ₂₈)	(>C ₂₈)
Push Probes										
SB-915(S)-5.0	31-Mar-04	5 to 6	<5	None	<20.0	<50.0	DET	--	<25.0	294
SB-916(S)-5.0	31-Mar-04	5 to 6	<5	None	<20.0	<50.0	<100	--	--	--
SB-917(S)-5.0	31-Mar-04	5 to 6	<5	None	<20.0	<50.0	<100	--	--	--
SB-918(S)-5.0	31-Mar-04	5 to 6	<5	None	<20.0	<50.0	<100	--	--	--
SB-919(S)-5.0	31-Mar-04	5 to 6	<5	None	<20.0	<50.0	<100	--	--	--
Test Pits										
EX-1/S-1	30-Mar-04	5	<5	None	--	--	--	<4.00	26.5	<50.0
EX-2/S-1	30-Mar-04	4	75	None	--	--	--	<4.00	<25.0	110
EX-2/S-2	01-Apr-04	1 1/2	60	None	--	--	--	<4.00	<25.0	<50.0
EX-3/S-1	31-Mar-04	3	<5	None	--	--	--	<4.00	770	760
EX-4/S-1	29-Mar-04	5	<5	None	<20.0	<50.0	<100	--	--	--

F:\DATA\Jobs\Shell\15227 Astoria Bulk Terminal\Pipeline Investigation\Report\15227 Pipeline Data Tables

Notes:

1. TPH-HCID: Total Petroleum Hydrocarbon Identificaiton by Northwest TPH Methodology.
2. TPH-Gx: Total Petroleum Hydrocarbons as Gasoline (C₇-C₁₂) by Northwest Method TPH-Gx.
3. TPH-Dx: Total Petroleum Hydrocarbons as Diesel (C₁₀-C₂₈) and Heavy Oil (>C₂₈) by Northwest Method TPH-Dx.
4. Detectable quantities are in bold type.
5. < = Analyte not present in sample at or above the indicated value.
6. -- = Not analyzed.
7. Analytical results reported on a dry weight basis.

**Table 2 - Chemical Analysis Results Summary: BTEX in Soil
Historical Shell/Niemi/Mobil Pipeline Investigation
Astoria Area Wide Petroleum Site, Astoria, Oregon**

Sample Identification	Sampling Date	Concentrations in Milligrams per Kilogram (mg/kg)			
		Benzene	Toluene	Ethyl-Benzene	Total Xylenes
Test Pits					
EX-1/S-1	30-Mar-04	<0.0500	<0.0500	<0.0500	<0.0500
EX-2/S-1	30-Mar-04	<0.0500	0.0530	0.0778	0.129
EX-3/S-1	31-Mar-04	<0.0500	<0.0500	<0.0500	<0.0500
EX-4/S-1	29-Mar-04	<0.0500	<0.0500	<0.0500	<0.0500

F:\DATA\Jobs\Shell\15227 Astoria Bulk Terminal\Pipeline Investigation\Report\15227 Pipeline Data Tables

Notes:

1. Benzene, toluene, ethylbenzene, and total xylenes (BTEX) by EPA Method 8021B.
2. Detectable quantities are in bold type.
3. < = Analyte not present in sample at or above the indicated value.
4. -- = Not analyzed.
5. The reported BTEX analysis was performed outside of the recommended holding time due to low analyte or surrogate recoveries in the initial analysis.
6. Analytical results reported on a dry weight basis.

**Table 3 - Polynuclear Aromatic Hydrocarbons (PAHs) in Soil
Historical Shell/Niemi/Mobil Pipeline Investigation
Astoria Area Wide Petroleum Site, Astoria, Oregon**

		Carcinogenic PAHs							Non-Carcinogenic PAHs								
		Benzo(a)anthracene	Chrysene	Benzo(b)fluoranthene	Benzo(k)fluoranthene	Benzo(a)pyrene	Indeno(1,2,3-cd)pyrene	Dibenzo(a,h)anthracene	Naphthalene	Acenaphthylene	Acenaphthene	Fluorene	Phenanthrene	Anthracene	Fluoranthene	Pyrene	Benzo(g,h,i)perylene
Sample Identification	Sampling Date	Concentrations in Milligrams per Kilogram (mg/kg)															
Push Probe SB-915(S)-5.0	31-Mar-04	<0.067	<0.067	<0.067	<0.067	<0.067	<0.067	<0.067	<0.067	<0.067	<0.067	<0.067	<0.067	<0.067	<0.067	<0.067	<0.067
Test Pits																	
EX-1/S-1	30-Mar-04	<0.0134	<0.0134	<0.0134	<0.0134	<0.0134	<0.0134	<0.0134	<0.0134	<0.0134	<0.0134	<0.0134	<0.0134	<0.0134	<0.0134	<0.0134	<0.0134
EX-2/S-1	30-Mar-04	<0.0134	<0.0134	<0.0134	<0.0134	<0.0134	<0.0134	<0.0134	0.0352	<0.0134	<0.0134	<0.0134	<0.0134	<0.0134	<0.0134	0.0162	0.0184
EX-3/S-1	31-Mar-04	0.0967	0.106	0.0941	<0.067	0.102	<0.067	<0.067	<0.067	<0.067	<0.067	0.0862	<0.067	0.152	0.194	0.0890	
EX-4/S-1	29-Mar-04	<0.0134	<0.0134	<0.0134	<0.0134	<0.0134	<0.0134	<0.0134	<0.0134	<0.0134	<0.0134	<0.0134	<0.0134	<0.0134	<0.0134	<0.0134	<0.0134

F:\DATA\Jobs\Shell\15227 Astoria Bulk Terminal\Pipeline Investigation\Report\15227 Pipeline Data Tables

Notes:

1. Polynuclear aromatic hydrocarbon (PAH) analysis by EPA Method 8270-SIM.
2. Detectable quantities are in bold type.
3. < = Analyte not detected at or above the indicated laboratory method reporting limit.
4. The extraction for PAH analysis on sample EX-4/S-1 was performed outside of the recommended holding time.
5. Analytical results reported on a dry weight basis.

Site Location Map
Historical Shell/Niemi/Mobil Pipeline Investigation
Astoria Area Wide Petroleum Site, Astoria, Oregon

F:\DATA\Jobs\Shell\15227 Astoria Bulk Terminal\Pipeline Investigation\Report\Figures\1522700 01 (Site Loc.) .cdr

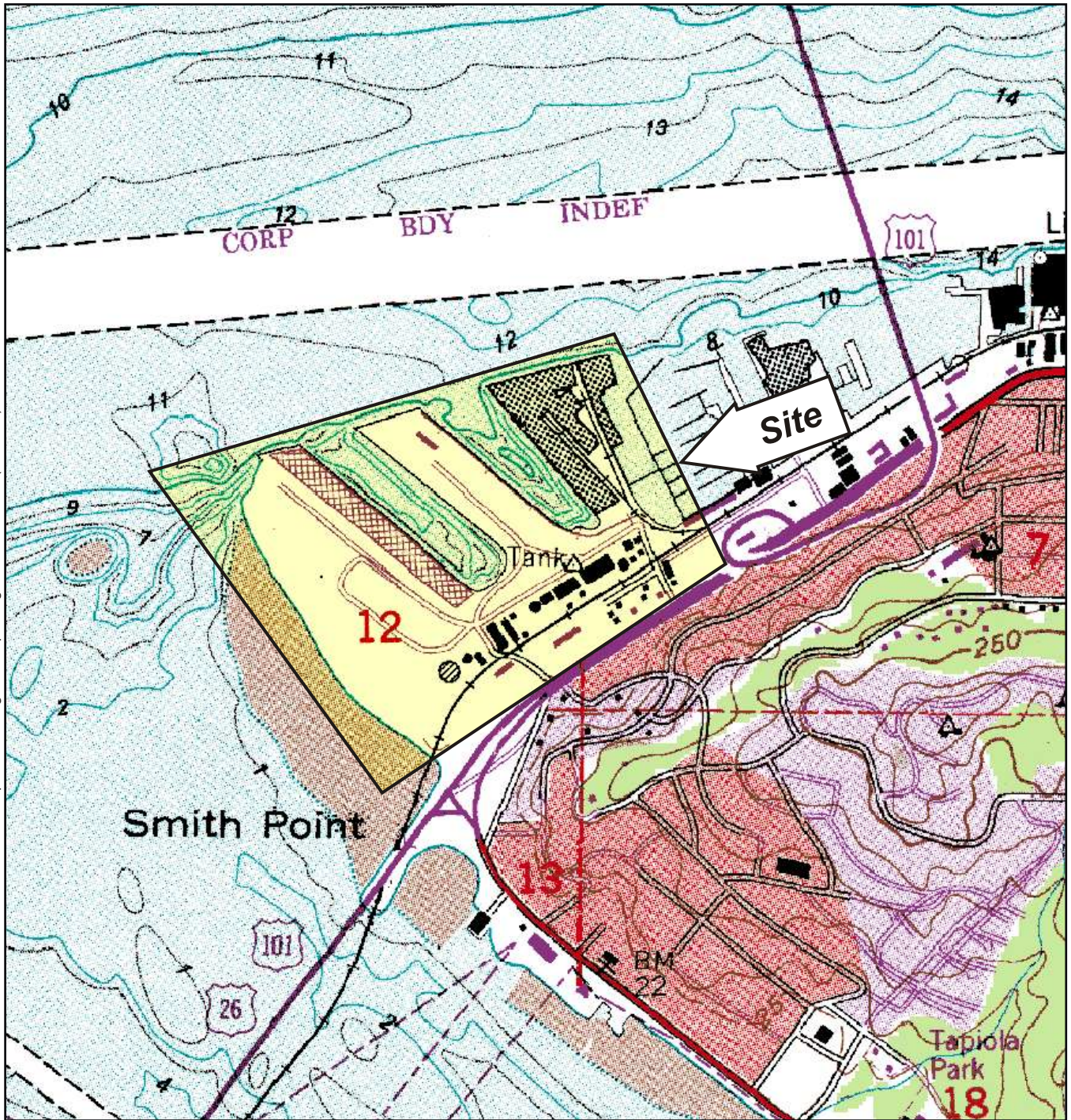

Note: Base map prepared from the USGS 7.5-minute quadrangle of Astoria, OR-WA, photorevised 1984.

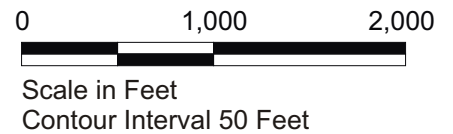

**Test Pit Excavation and Push Probe Locations
 Historical Shell/Niemi/Mobil Pipeline Investigation
 Astoria Area Wide Petroleum Site, Astoria, Oregon**

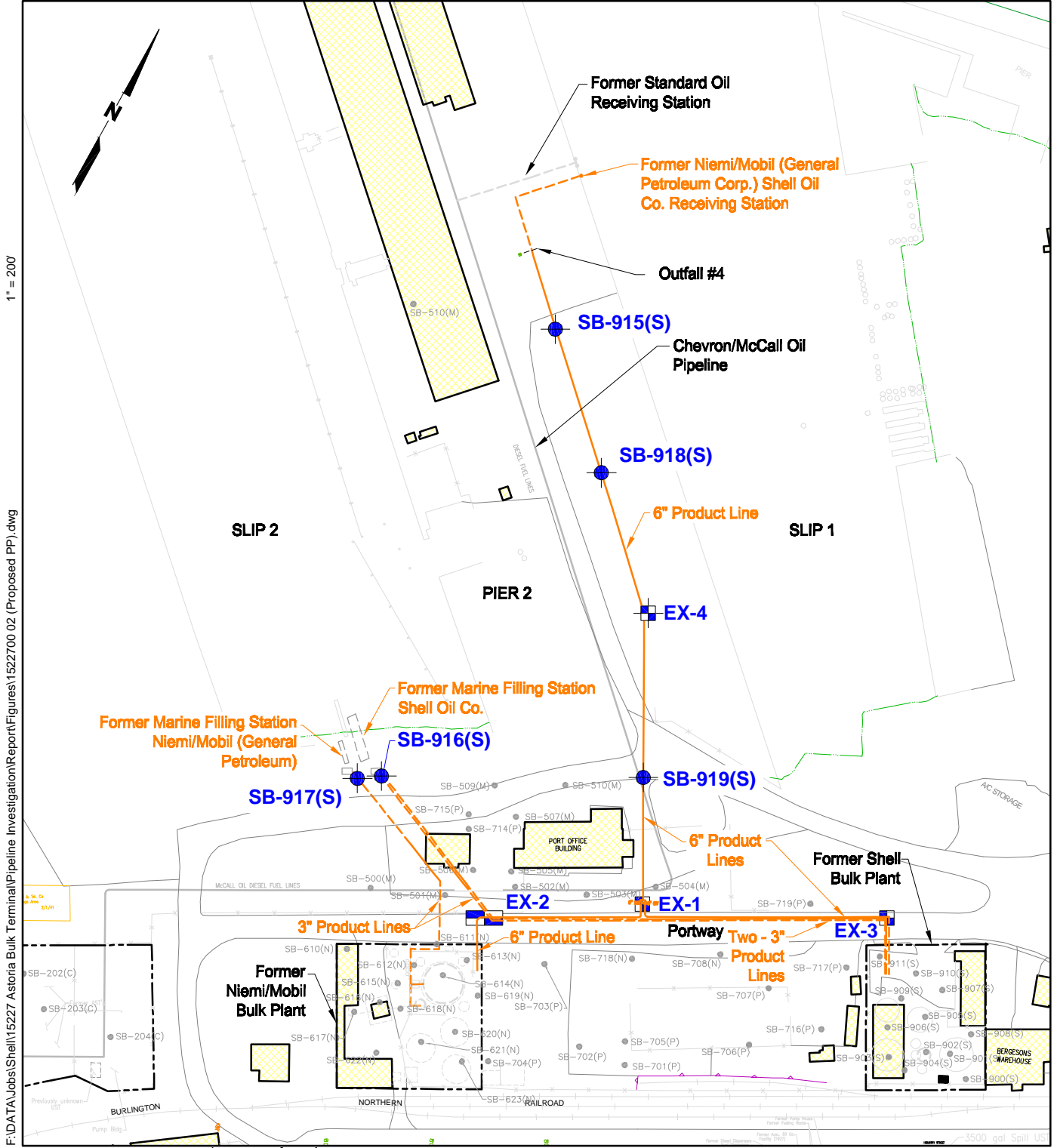

F:\DATA\Jobs\Shell\15227 Astoria Bulk Terminal\Pipeline Investigation\Report\Figures\1522700 02 (Proposed PP).dwg
 1" = 200'
 14. Co
 Area
 2/11

Note: Base map prepared from AutoCAD file provided by EnviroLogic Resources, Inc. and the 1927 Port of Astoria Utility Map.

Legend:

- SB-915(S)** ● Soil Exploration Location and Number (3/04)
- EX-5** ■ Test Pit Location and Number
- SB-705(P) ● Soil Exploration Location and Number (Phase I)
- Niemi/Mobil/Shell Product Line
(Dashed Where Not Verified by Geophysical Survey or Test Pits)

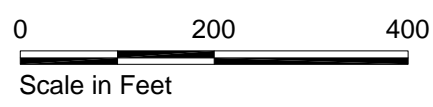

HARTCROWSER
 15227-00 6/04
 Figure 2

Test Pit Excavation Locations Historical Shell/Niemi/Mobil Pipeline Investigation Astoria Area Wide Petroleum Site, Astoria, Oregon

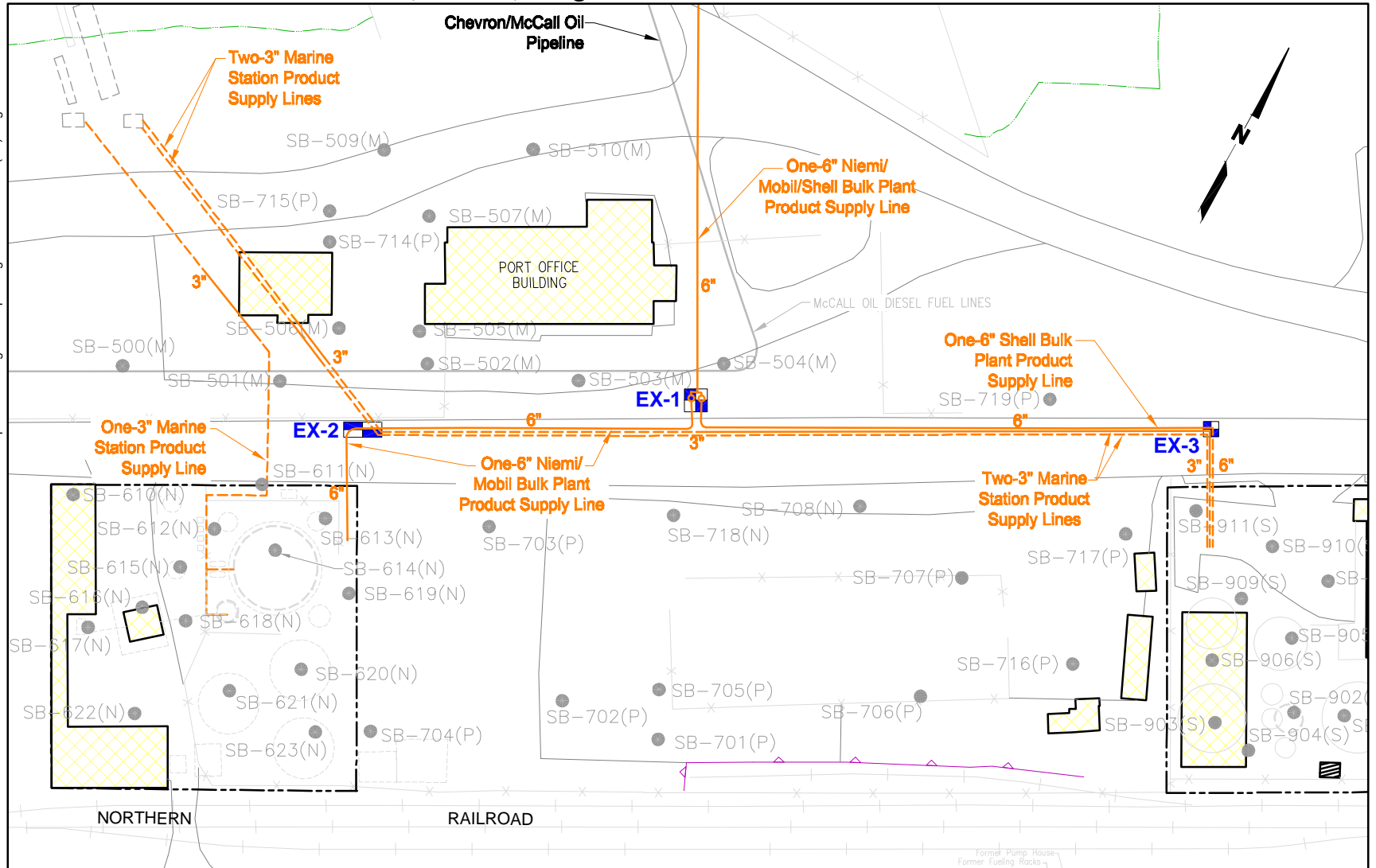

Note: Base map prepared from AutoCAD file provided by EnviroLogic Resources, Inc. and the 1927 Port of Astoria Utility Map.

Legend:

- EX-1 Test Pit Excavation and Number
- SB-705(P) Soil Exploration Location and Number
- Niemi/Mobil/Shell Product Line (Dashed Where Not Verified by Geophysical Survey or Test Pits)

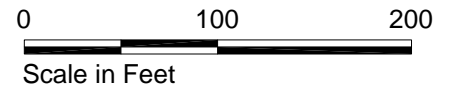

APPENDIX A
FIELD METHODS, EXPLORATION LOGS, AND DISPOSAL RECEIPTS

APPENDIX A FIELD METHODS, EXPLORATION LOGS, AND DISPOSAL RECEIPTS

1.0 INTRODUCTION

This appendix presents the field procedures used to investigate and decommission the historical Shell/Niemi/Mobil pipeline system. These activities were conducted as part of the Astoria Area Wide Petroleum Site investigation. The field activities for this investigation included completing push probe and test pit explorations, collecting and submitting soil samples for chemical analyses, inspecting and decommissioning the pipelines, and restoring the test pit exploration areas to pre investigation conditions.

Terra Hydr, under direct contract to Shell, completed the test pit explorations, pipeline decommissioning, and site restoration activities; and Geo-Tech Explorations, Inc., under direct contract to the Astoria Area Wide Potentially Responsible Parties Group (PRP Group), completed the push probe explorations. A Hart Crowser representative was present to collect soil samples and observe and document all site activities. Detailed field notes and logs were maintained for each exploration and excavation. Push probe exploration logs are included in this appendix as Figures A-2 through A-6. Test pit excavation logs showing cross-sectional and plan views of each test pit are included as Figures A-7 through A-10. Figure A-1 provides an explanation of soil descriptions and symbols used on the logs. The field procedures included the following:

- Push probe soil sampling;
- Test pit excavation and soil sampling;
- Field screening;
- Pipeline inspection and decommissioning;
- Site restoration;
- Sample management;
- Decontamination procedures;
- Handling of investigation-derived waste; and
- Field quality assurance/quality control (QA/QC).

2.0 PUSH PROBE SOIL SAMPLING

Sample Collection. Soil samples were collected continuously from directly beneath the asphalt concrete/base gravel to the total depth of each exploration. The sampling procedure includes driving a 2-inch-diameter, 4-foot-long push probe soil sampler to the desired depth using a combination of hydraulic pressure and mechanical hammer blows. As the probe is advanced, the soil core enters the sampler, lined with a clean cellulose acetate butylate (CAB) sleeve that was previously placed within the sampler. After the sampler has been advanced 4 feet, the sampler is withdrawn from the exploration. The sleeve is then removed from the sampler and cut lengthwise to expose the soil core for description and sampling.

The Hart Crowser representative transferred soil from the sleeve and placed the soil into labeled, laboratory-supplied sample jars using a clean stainless steel spoon. Sample jars were fully filled, leaving no headspace to minimize the potential loss of volatiles unless there was not sufficient sample available due to poor recovery. All containers were marked with a sample number, date of collection, project number, and sampler's initials. Samples were then placed in a cooler with ice for field storage and transport to the analytical laboratory. Chain of custody was maintained and documented throughout the sample collection and handling process.

Field Screening. Petroleum-like staining and/or odors (if present) were noted and described in the field notes. Each sample was screened in the field for the presence of volatile petroleum compounds using a photoionization detector (PID) and for non-volatile petroleum hydrocarbons using a sheen test. Please see Section 4.0 for additional discussion regarding PID and sheen testing procedures.

Push Probe Exploration Abandonment. After sampling activities were completed, each exploration was filled with granular bentonite to within 6 inches of the ground surface and hydrated with water. Gravel was then added to the boring from the top of the hydrated bentonite to the ground surface to complete the abandonment.

3.0 TEST PIT EXCAVATION AND SOIL SAMPLING

All test pit locations were in areas surfaced with asphalt concrete. The estimated lateral extent of each test pit was marked on the asphalt concrete and the asphalt concrete was cut using a water-cooled carbide saw. The asphalt concrete was then removed using the excavator bucket and stockpiled

at a central location for later use by the Port of Astoria as fill material. Soil was then removed from the test pit using an excavator and by hand digging with shovels adjacent to the petroleum pipelines and other utilities that may have been present in the test pit excavation. Excavated material from excavations EX-1, EX-3, and EX-4 was placed on the asphalt concrete surface adjacent to each respective excavation location. Soil from EX-2 exhibited a slightly weathered, petroleum-like odor at the time of excavation and was spread out on plastic sheeting to aerate until the excavation and pipeline decommissioning activities were completed and the EX-2 site was restored.

Sample Collection. Soil samples were generally collected from undisturbed soil beneath the exposed pipelines using a clean stainless steel spoon and transferred directly to a labeled, laboratory-supplied sample jar. Sample jars were fully filled leaving no headspace to minimize the potential loss of volatiles. Samples were then placed in a cooler with ice for field storage and transport to the analytical laboratory. Chain of custody was maintained and documented throughout the sample collection and handling process.

Field Screening. Petroleum-like staining and/or odors (if present) were noted and described in the field notes. Each sample was screened in the field for the presence of volatile petroleum hydrocarbons using a PID and for non-volatile petroleum hydrocarbons using a sheen test. Please see Section 4.0 for additional discussion regarding PID and sheen testing procedures.

4.0 FIELD SCREENING

Headspace Measurements. Headspace vapor measurements were made on soil samples using a PID to assess the possible presence of volatile petroleum compounds. Soil samples were placed in glass jars (filled less than half full), covered with aluminum foil prior to capping, placed inside the field vehicle and allowed to warm. PID measurements were generally made within 30 minutes of collection by removing the cap and pushing the 10.2 eV PID probe through the foil cover. The PID measurements were recorded in the field notes and are noted in Table 1 and on the exploration logs. The PID was calibrated prior to field use using a manufacturer-supplied standard gas.

Sheen Tests. Sheen tests were conducted on soil samples to assess if non-volatile petroleum hydrocarbons were present. A small portion of the soil sample was placed in a wide-mouth, glass jar partially filled with water. The presence of petroleum hydrocarbons was indicated if sheen was produced on the water surface in the jar. Observations were recorded in our field notes and are noted in Table 1 and on the exploration logs.

5.0 PIPELINE INSPECTION AND DECOMMISSIONING

Pipeline Inspections. The pipeline sections exposed in each excavation were visually inspected for indications of historical petroleum releases by noting presence (or absence) of rust, pitting, holes, and staining and/or leak at joints or flange connections. A 1/2-inch hole was then drilled in the top of the exposed pipe. Sorbent pads and a bucket were placed beneath each line to prevent the discharge of product, if present, to the underlying soils prior to drilling. A rod was then lowered into the pipe to determine if any liquid (product and/or water) was present, and PID and combustible gas probes were placed in the opening to assess the presence of volatile compounds and combustible gases (in percent of lower explosion limit [LEL]). If LEL readings were acceptable (less than 10 percent), a 2-inch-diameter hole was saw cut into the top of the pipe to allow inspection of the inside of the pipe. The inside condition of the pipe and the presence or absence of water and/or product were noted in the field notes.

Pipeline Decommissionings. Water with no sheen, odor, or detectable PID reading was present in the pipe exposed in the EX-2 excavation. A vertical saw cut was completed in the pipe and the water was allowed to drain directly into the excavation. Water with an odor and sheen and emulsified water/product were present in the 3-inch-diameter and 6-inch-diameter pipes exposed in the EX-3 excavation. The oily water and emulsified water/product were removed to the extent practicable (less than 1/4 inch remaining) from these lines using a vacuum truck.

The exposed pipeline sections in each excavation were decommissioned in place using quick setting Portland cement based grout. The grouting procedure consisted of pouring grout into the pipe opening until the opening overflowed. The pipeline was then tapped with a hammer to facilitate the removal of air pockets, and the grout was allowed to settle for several minutes. The filling and tapping/settling process was repeated several times until grout settlement ceased and the pipe was completely full at the access hole and would no longer accept additional grout. In addition, the concrete vault encountered in excavation EX-1 was completely filled with Portland cement concrete to further encase the exposed piping, gate valves and fittings, and to prevent future settling in this area.

6.0 SITE RESTORATION

The excavations were abandoned and the disturbed areas restored following the test pit description, soil sampling, and pipeline decommissioning activities. Excavations EX-3 and EX-4 were backfilled in reverse order (last out, first in) with

the stockpiled excavated soil. After two days of aeration, the soil from EX-2 did not exhibit a petroleum-like odor or yield a detectable PID measurement, and was returned to the EX-2 excavation. All three excavations were backfilled to within 6 inches of surrounding grade and compacted in 2-foot lifts to a non-yielding state using a vibratory compactor.

Excavated soil was not returned to the concrete vault in excavation EX-1 because the configuration of the high-voltage power lines and multiple pipes within the concrete vault restricted soil placement and compaction. To ensure subsequent settlement would not occur, the concrete vault was completely filled with Portland cement concrete. Concrete was also placed in the remaining excavation up to the top of the exposed pipes (about 2 feet below ground surface [bgs]). Excavated soil was then placed in the EX-1 excavation to within six inches of surrounding grade and compacted to a non-yielding state using a vibratory compactor.

The surface restoration for all excavations consisted of three inches of compacted crushed gravel capped with three inches of asphalt concrete.

7.0 SAMPLE MANAGEMENT

Containers. The analytical laboratory provided clean sample containers ready for sample collection, appropriate for the planned analyses. Each container was fully filled, leaving no headspace (unless there was insufficient sample available due to poor recovery).

Labeling Requirements. A sample label was affixed to each sample container before sample collection. All containers were marked with the project number, a sample number, date of collection, and sampler's initials.

Sample Storage and Shipment. All samples were stored in an ice chest cooled with blue ice for field storage and transport to the analytical laboratory. Chain of custody was maintained and documented throughout the sample handling process.

Field Chain of Custody Procedures. Sample chain of custody refers to the process of tracking the possession of a sample from the time it is collected in the field through the laboratory analysis. A sample is considered to be under a person's custody if it is as follows:

- In a person's physical possession;
- In view of the person after possession has been taken; or

- Secured by that person so that no one can tamper with the sample or secured by that person in an area that is restricted to authorized personnel.

A chain of custody form was used to record possession of a sample and to document the requested analyses. Each time the sample bottles or samples were transferred between individuals, both the sender and receiver signed and dated the chain of custody form.

8.0 DECONTAMINATION PROCEDURES

Personnel Decontamination. Personnel decontamination procedures depend on the level of protection specified for a given activity. The Health and Safety Plan identified the appropriate level of protection for the type of fieldwork and conditions involved in this project. Field personnel thoroughly washed their hands at the end of each day and before taking any work breaks.

Sampling Equipment Decontamination. Clean, dedicated sampling equipment (e.g., push probe sampling sleeves) was used when possible for each sampling event and was discarded after use to prevent cross-contamination between sampling events. Cleaning of non-disposable items consisted of washing in a detergent (Alconox®) solution, rinsing with tap water, followed with a deionized water rinse. To reduce the chance for cross contamination between explorations, the push probe sampler was cleaned with a high-pressure washer after each exploration.

9.0 HANDLING OF INVESTIGATION-DERIVED WASTE

Generated investigation-derived waste (IDW) consisted of asphalt concrete, oily water and emulsified water/product, equipment decontamination water, and personal protection supplies. The asphalt concrete was stockpiled at a central location on the site for future use as site fill material. The IDW oily water and emulsified water/product were removed from the pipelines exposed in excavation EX-3 by a vacuum truck and transported to Oil Re-Refining Company in Portland, Oregon, for treatment and recycling. Copies of the transport and disposal receipts are included in this appendix.

Personal protection supplies (e.g., gloves, paper towels) and other dedicated disposable supplies were deposited into plastic bags at the site and transported to Hart Crowser's office and disposed of in a dumpster as a solid waste. IDW equipment decontamination water was placed in the on-site Baker tank used to

store monitoring well purge and decontamination water and will be discharged to a nearby storm drain in accordance with established procedures.

10.0 FIELD QUALITY ASSURANCE/QUALITY CONTROL

QA/QC was practiced throughout the field activities. As discussed above, all sampling equipment was decontaminated or disposed of between each sampling event. All laboratory containers were marked with the project number, a unique sample identification number, the date and time of collection, and the sampler's initials. Each sample container was packed in a cooled ice chest for field storage and transport. The QA review of the laboratory data is presented in Appendix C of this report.

Key to Exploration Logs

Sample Descriptions

Classification of soils in this report is based on visual field and laboratory observations which include density/consistency, moisture condition, and grain size, and should not be construed to imply field nor laboratory testing unless presented herein. Visual-manual classification methods of ASTM D 2488 were used as an identification guide. Color was described using the Munsel System.

Soil descriptions consist of the following:

Density/consistency, moisture, color, minor constituents, MAJOR CONSTITUENT with additional remarks.

Density/Consistency

Soil density/consistency in borings is related primarily to the Standard Penetration Resistance. Soil density/consistency in test pits and push probe explorations is estimated based on visual observation and is presented parenthetically on test pit and push probe exploration logs.

SAND and GRAVEL	Standard Penetration Resistance in Blows/Foot	SILT or CLAY	Standard Penetration Resistance in Blows/Foot	Approximate Shear Strength in TSF
Density		Density		
Very loose	0 - 4	Very soft	0 - 2	<0.125
Loose	4 - 10	Soft	2 - 4	0.125 - 0.25
Medium dense	10 - 30	Medium stiff	4 - 8	0.25 - 0.5
Dense	30 - 50	Stiff	8 - 15	0.5 - 1.0
Very dense	>50	Very Stiff	15 - 30	1.0 - 2.0
		Hard	>30	>2.0

Moisture

Dry	Little perceptible moisture.
Damp	Some perceptible moisture, probably below optimum.
Moist	Probably near optimum moisture content.
Wet	Much perceptible moisture, probably above optimum.

Minor Constituents





Estimated Percentage

Not identified in description	0 - 5
Slightly (clayey, silty, etc.)	5 - 12
Clayey, silty, sandy, gravelly	12 - 30
Very (clayey, silty, etc.)	30 - 50



Legends

Sampling Symbols

BORING AND PUSH PROBE SYMBOLS

-  Split Spoon
-  Tube (Shelby, Push Probe)
-  Cuttings
-  Core Run
-  Temporarily Screened Interval
- N Standard Penetration Resistance
- * No Sample Recovery
- PID Photoionization Detector Reading

TEST PIT SOIL SAMPLES

-  Grab (Jar)
-  Bag
-  Shelby Tube

Groundwater Observations and Monitoring Well Construction

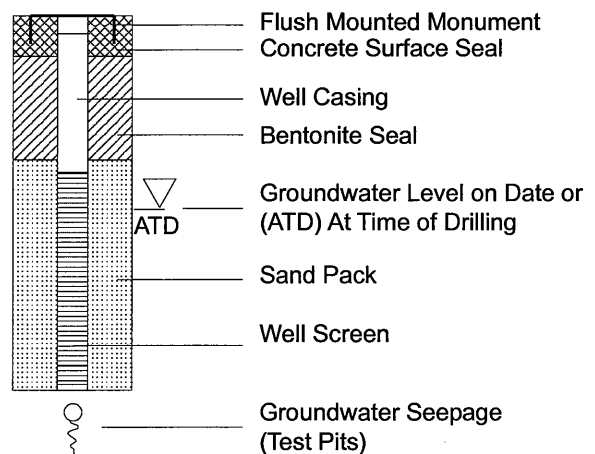

Push Probe Boring Log SB-915 (S)

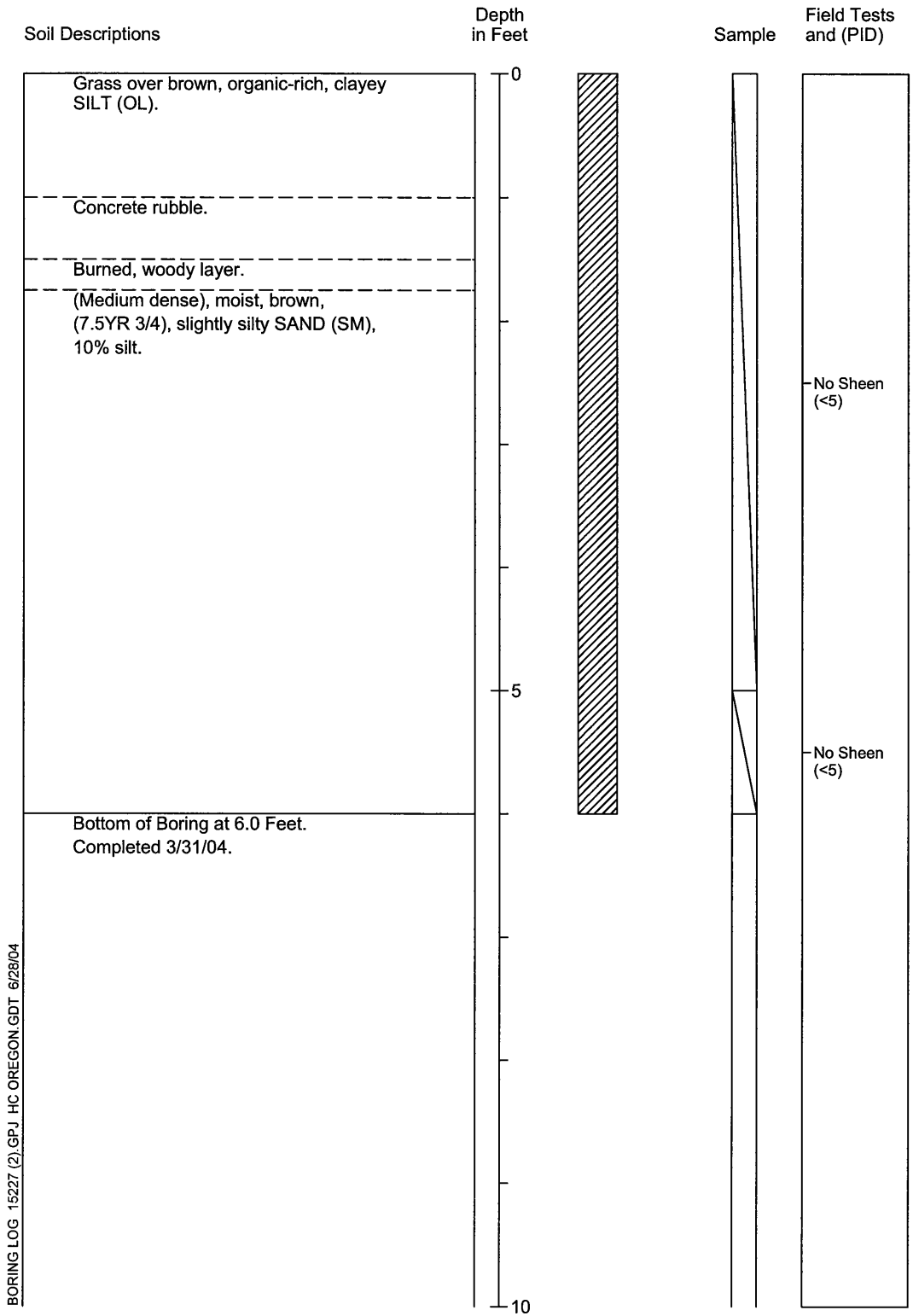

1. Refer to Figure A-1 for explanation of descriptions and symbols.
2. Descriptions and stratum lines are interpretive and actual changes may be gradual.
3. Groundwater level, if indicated, is at time of drilling (ATD) or for date specified. Level may vary with time.

Push Probe Boring Log SB-916 (S)

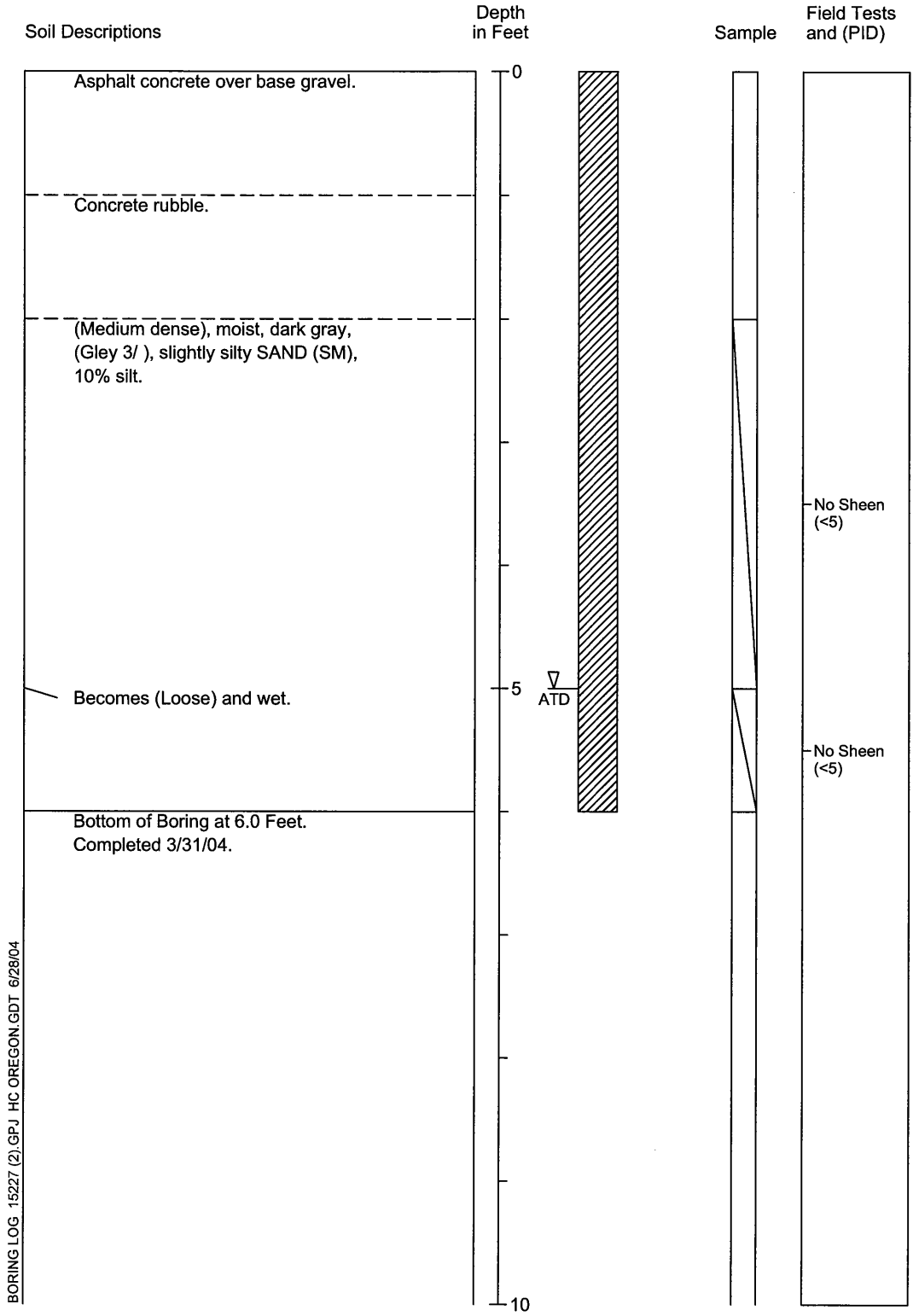

BORING LOG 15227 (2).GPJ HC OREGON GDT 6/28/04

1. Refer to Figure A-1 for explanation of descriptions and symbols.
2. Descriptions and stratum lines are interpretive and actual changes may be gradual.
3. Groundwater level, if indicated, is at time of drilling (ATD) or for date specified. Level may vary with time.

Push Probe Boring Log SB-917 (S)

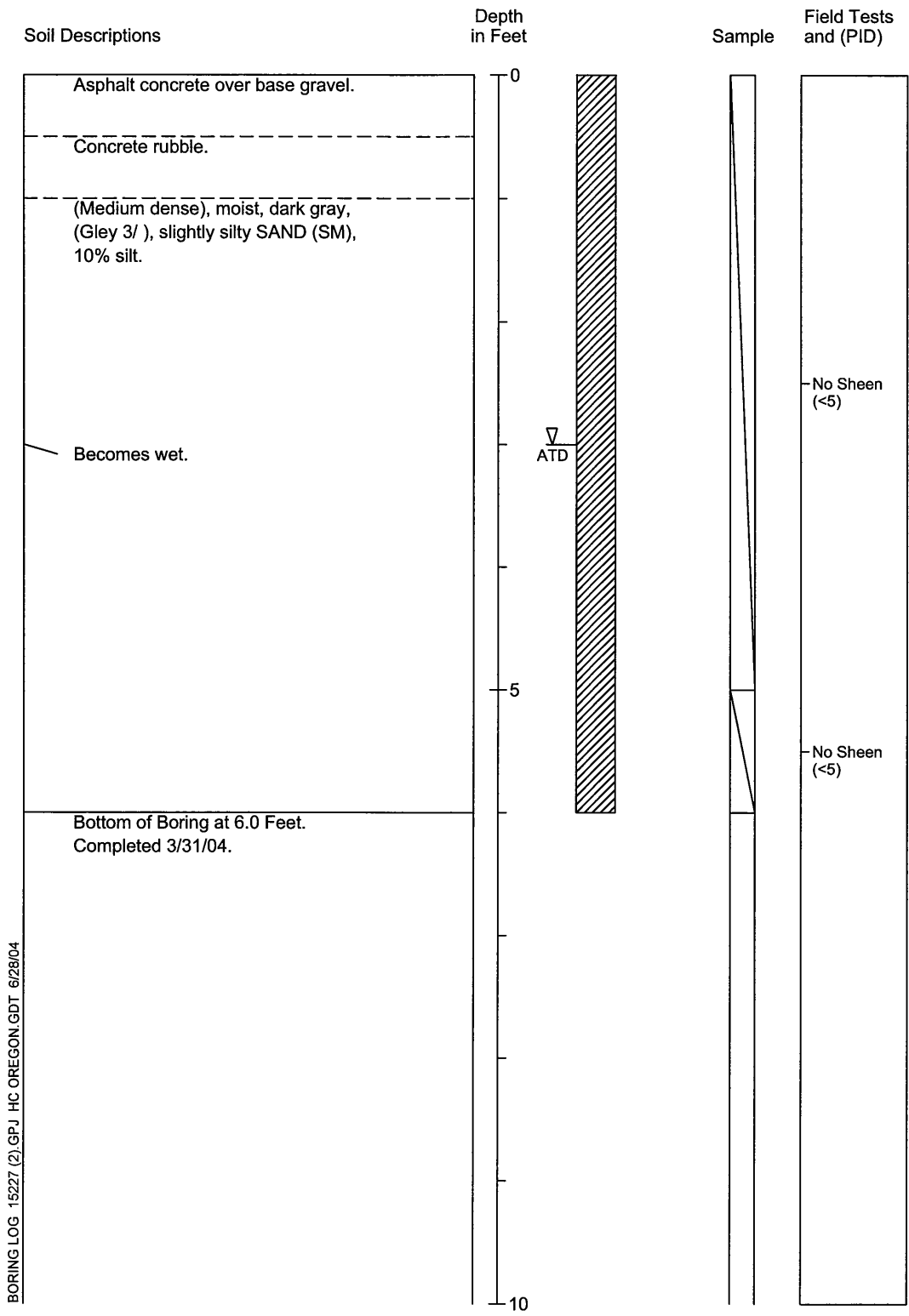

BORING LOG 15227 (2) GPJ HC OREGON GDT 6/28/04

1. Refer to Figure A-1 for explanation of descriptions and symbols.
2. Descriptions and stratum lines are interpretive and actual changes may be gradual.
3. Groundwater level, if indicated, is at time of drilling (ATD) or for date specified. Level may vary with time.

Push Probe Boring Log SB-918 (S)

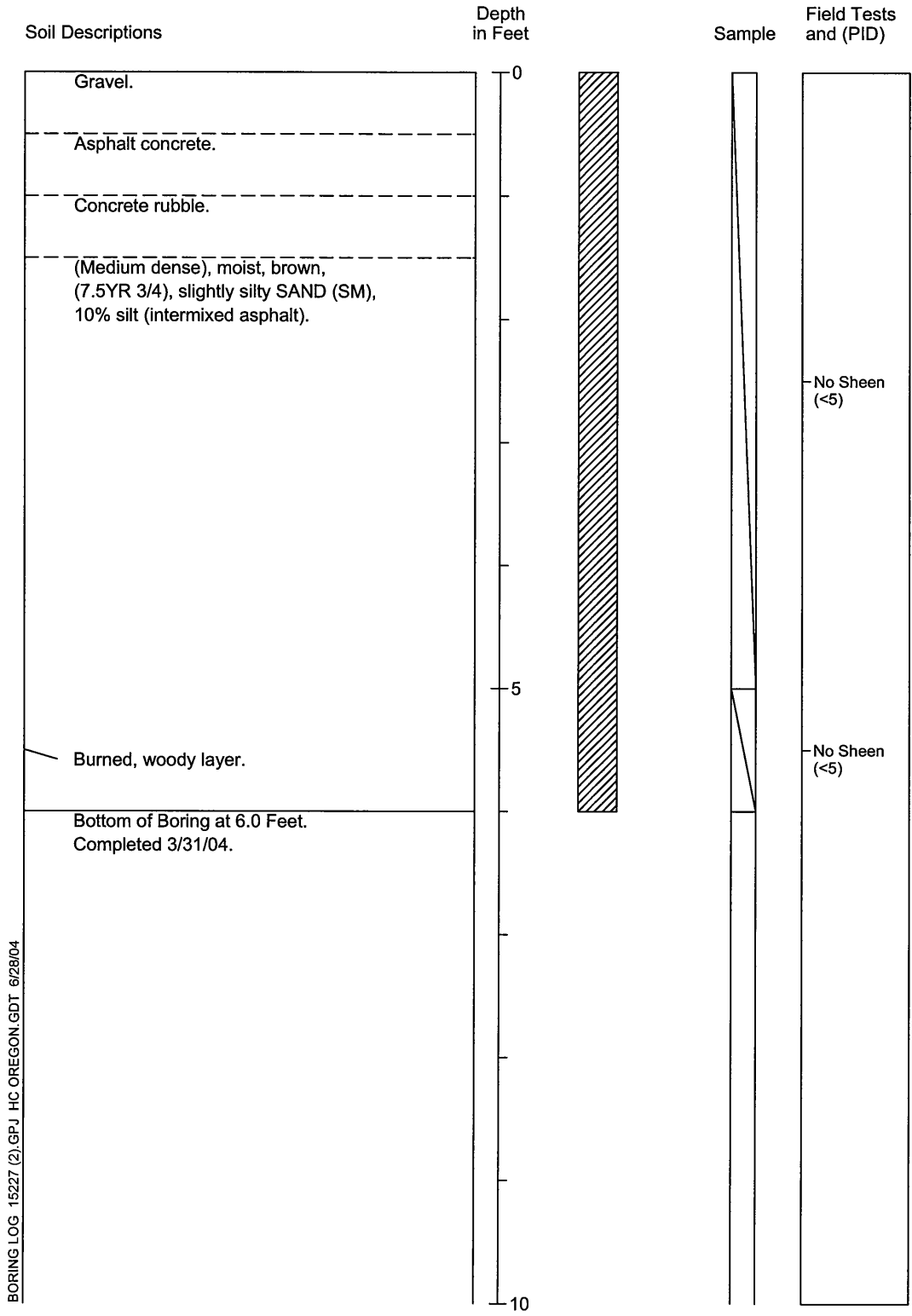

BORING LOG 15227 (2).GPJ HC OREGON.GDT 6/28/04

1. Refer to Figure A-1 for explanation of descriptions and symbols.
2. Descriptions and stratum lines are interpretive and actual changes may be gradual.
3. Groundwater level, if indicated, is at time of drilling (ATD) or for date specified. Level may vary with time.

Push Probe Boring Log SB-919 (S)

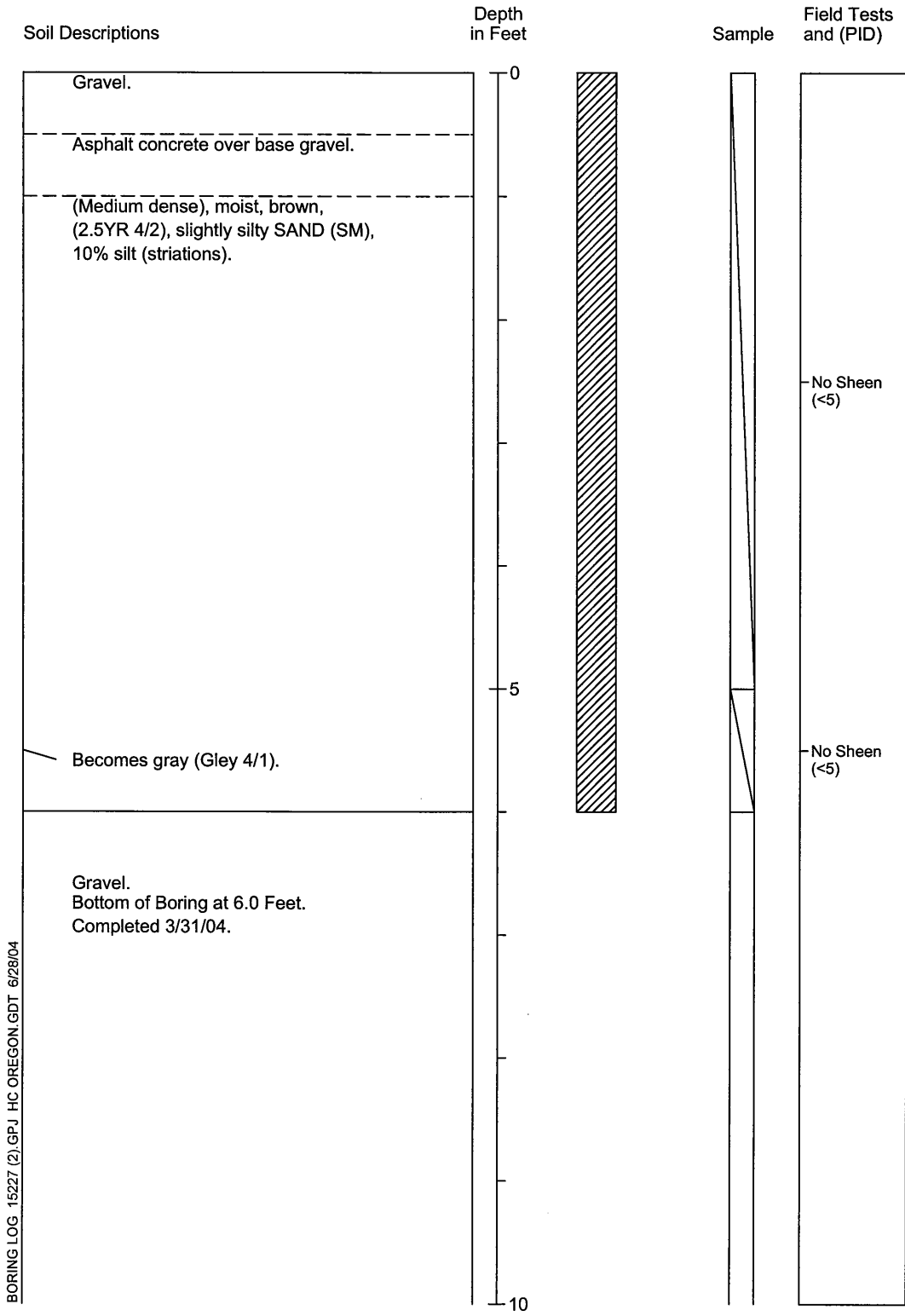

BORING LOG 15227 (2).GPJ HC OREGON.GDT 6/28/04

1. Refer to Figure A-1 for explanation of descriptions and symbols.
2. Descriptions and stratum lines are interpretive and actual changes may be gradual.
3. Groundwater level, if indicated, is at time of drilling (ATD) or for date specified. Level may vary with time.

Test Pit EX-1
Historical Shell/Niemi/Mobil Pipeline Investigation
Astoria Area Wide Petroleum Site, Astoria, Oregon

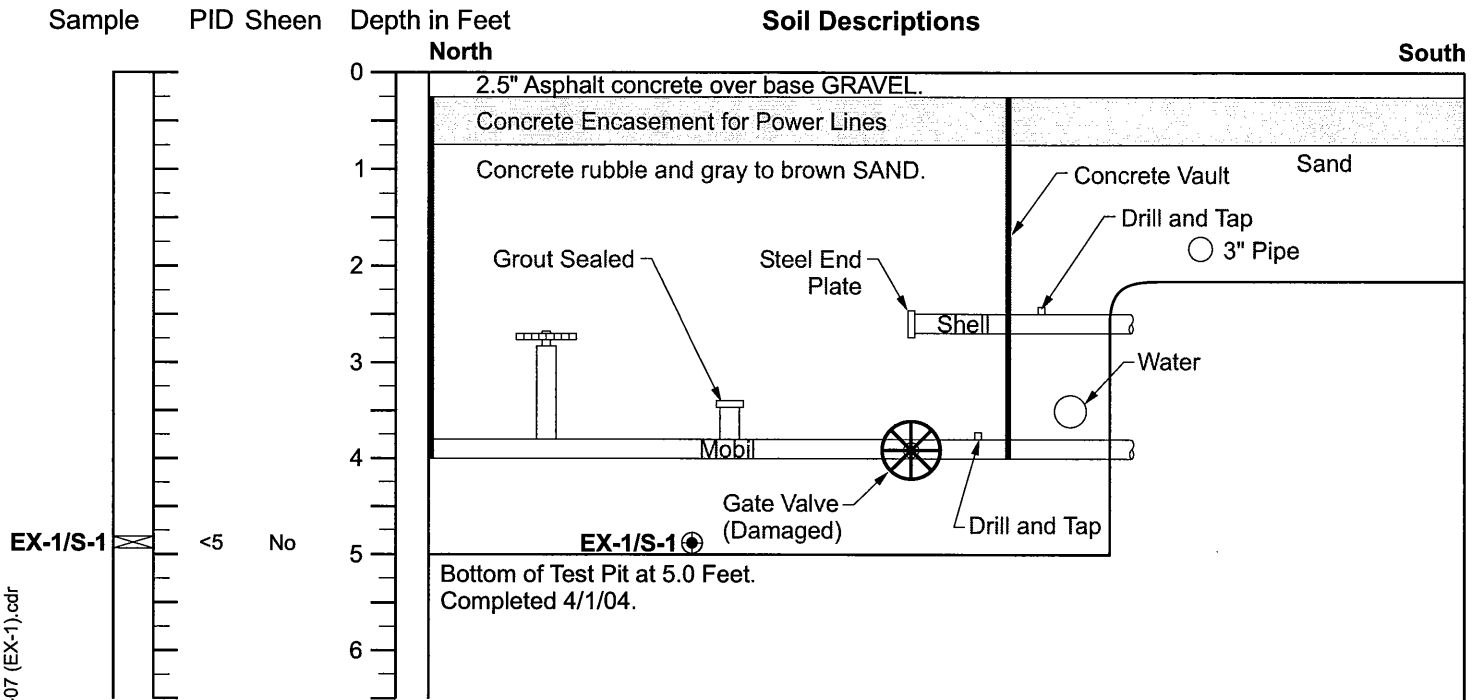

Test Pit EX-1 Plan View

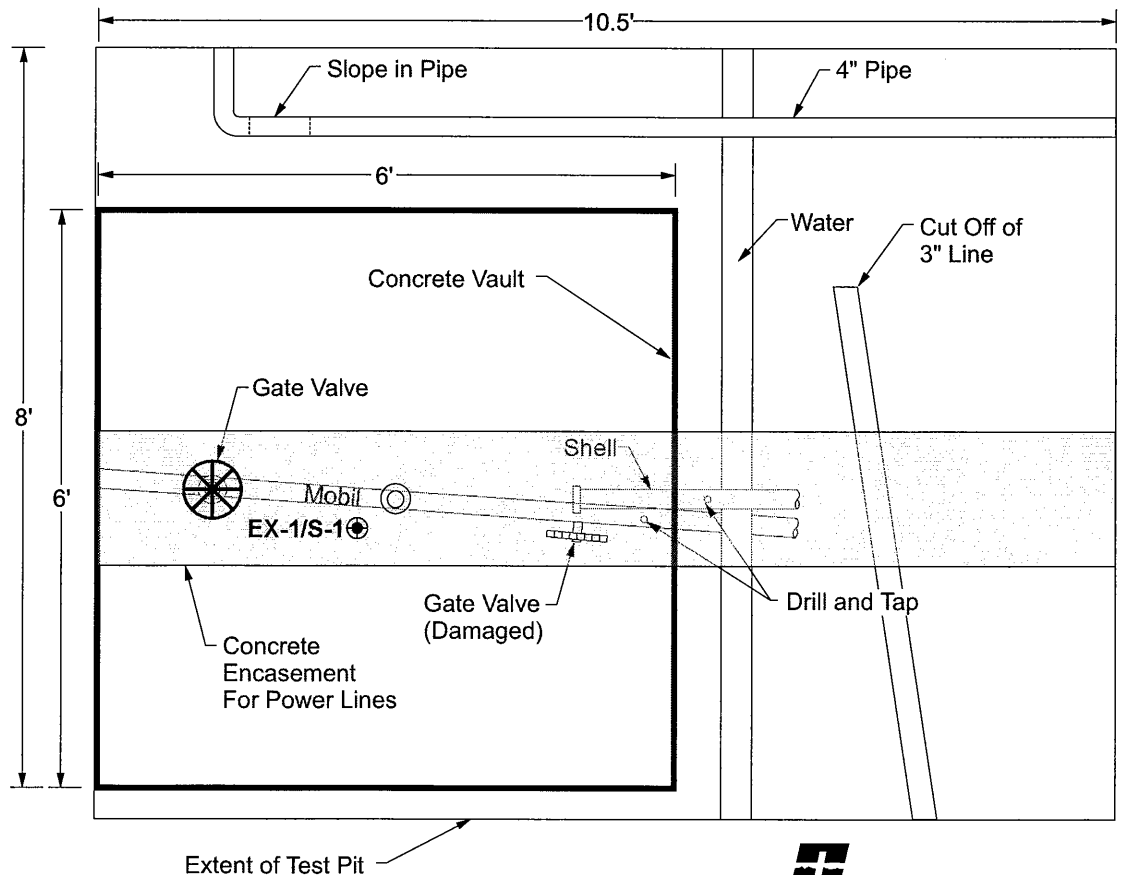

Notes:

1. Refer to Figure A-1 for explanation of descriptions and symbols.
2. Soil descriptions and stratum lines are interpretive and actual changes may be gradual.
3. Groundwater level, if indicated, was at time of test pit exploration. Level may vary with time.

F:\DATA\Jobs\Shell\15227 Astoria Bulk Terminal\Pipeline Investigation\Report\Figures\Test Pits\1522700 A-07 (EX-1).cdr

Test Pit EX-2
Historical Shell/Niemi/Mobil Pipeline Investigation
Astoria Area Wide Petroleum Site, Astoria, Oregon

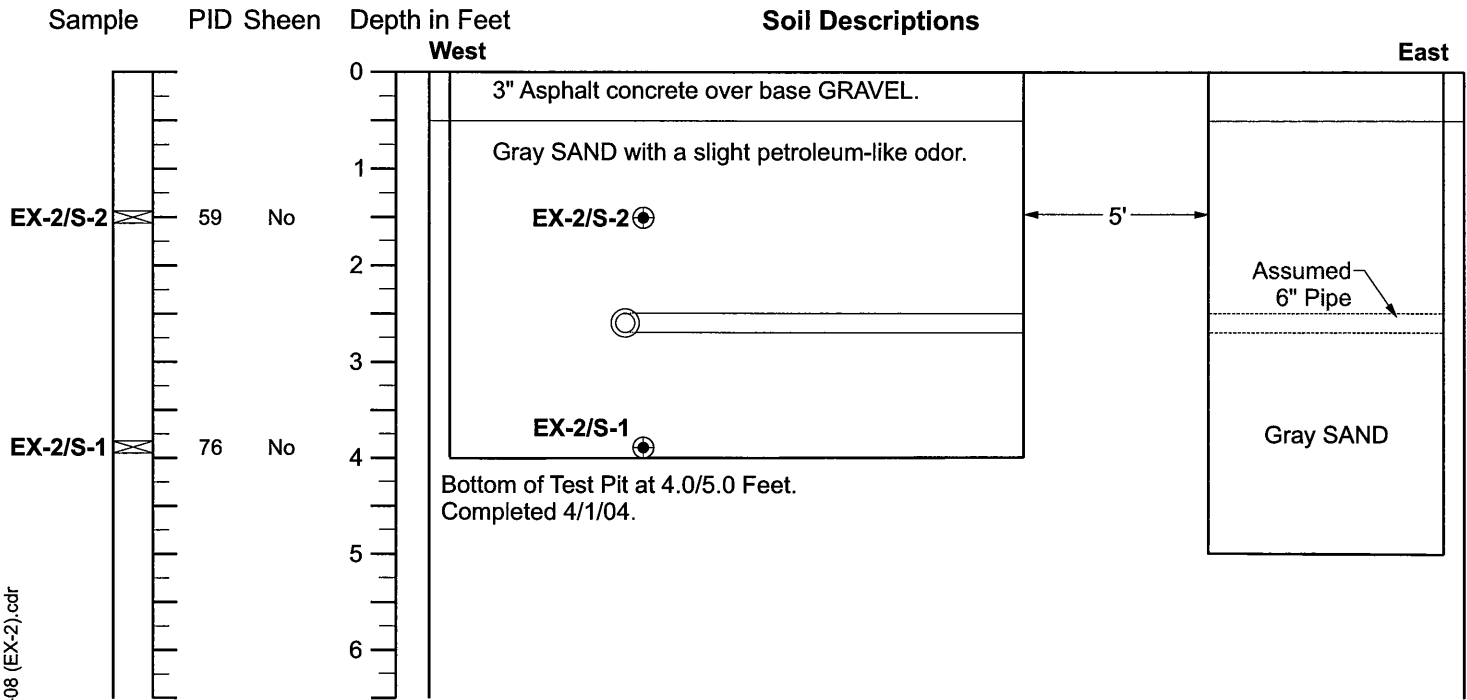

Test Pit EX-2 Plan View

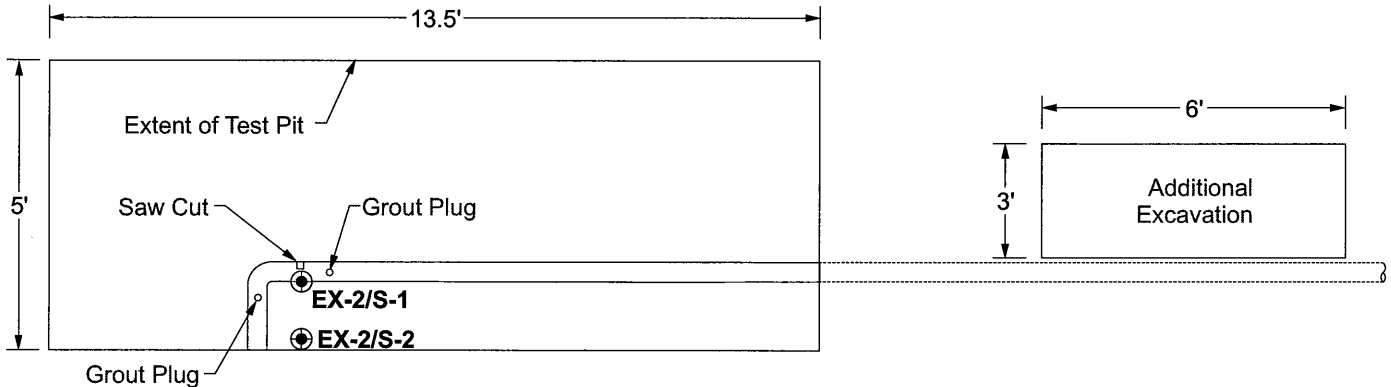

Notes:

1. Refer to Figure A-1 for explanation of descriptions and symbols.
2. Soil descriptions and stratum lines are interpretive and actual changes may be gradual.
3. Groundwater level, if indicated, was at time of test pit exploration. Level may vary with time.

F:\DATA\Jobs\Shell\15227 Astoria Bulk Terminal\Pipeline Investigation\Report\Figures\Test Pits\1522700 A-08 (EX-2).cdr

Test Pit EX-3

Historical Shell/Niemi/Mobil Pipeline Investigation

Astoria Area Wide Petroleum Site, Astoria, Oregon

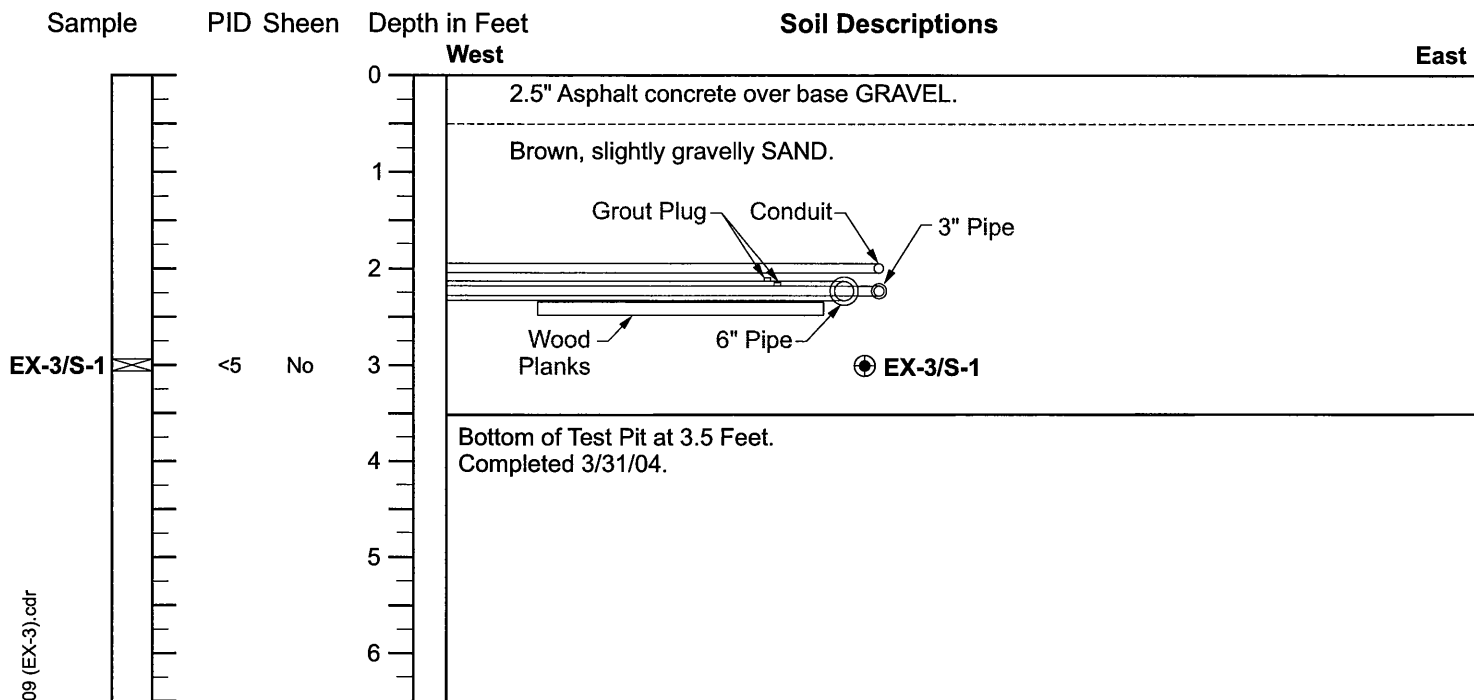

F:\DATA\Jobs\Shell\15227 Astoria Bulk Terminal\Pipeline Investigation\Report\Figures\Test Pits\1522700 A-09 (EX-3).cdr

Test Pit EX-3 Plan View

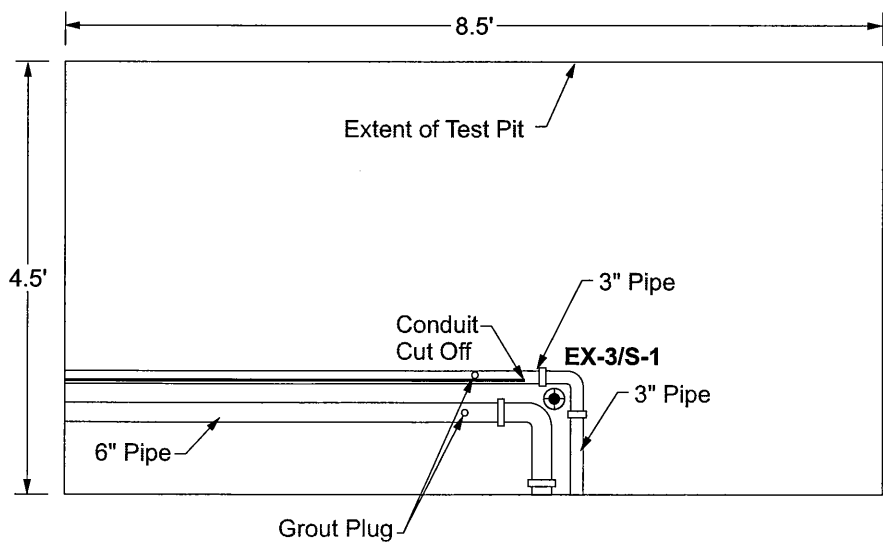

Notes:

1. Refer to Figure A-1 for explanation of descriptions and symbols.
2. Soil descriptions and stratum lines are interpretive and actual changes may be gradual.
3. Groundwater level, if indicated, was at time of test pit exploration. Level may vary with time.

Test Pit EX-4
Historical Shell/Niemi/Mobil Pipeline Investigation
Astoria Area Wide Petroleum Site, Astoria, Oregon

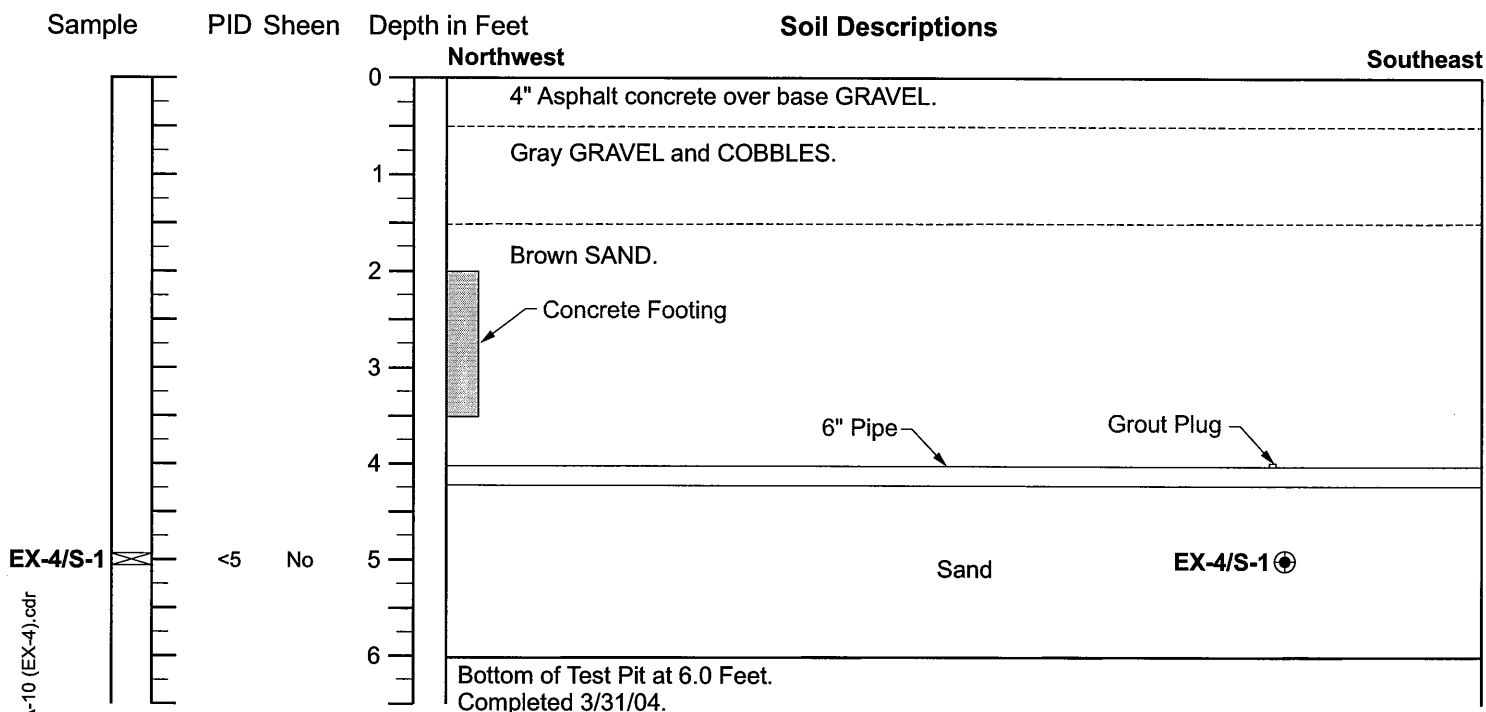

Test Pit EX-4 Plan View

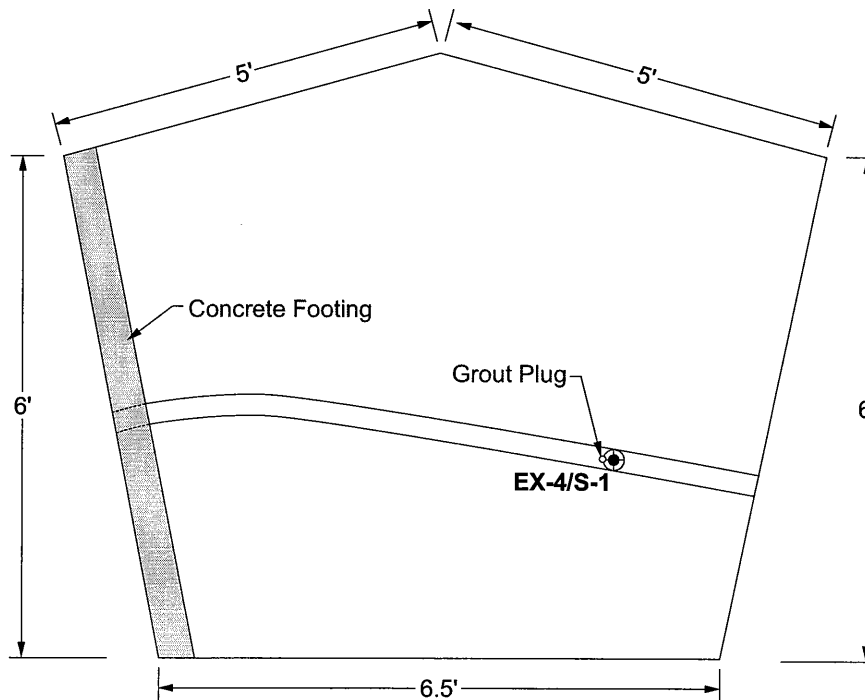

Notes:

1. Refer to Figure A-1 for explanation of descriptions and symbols.
2. Soil descriptions and stratum lines are interpretive and actual changes may be gradual.
3. Groundwater level, if indicated, was at time of test pit exploration. Level may vary with time.

F:\DATA\Jobs\Shell\15227 Astoria Bulk Terminal\Pipeline Investigation\Report\Figures\Test Pits\1522700 A-10 (EX-4).cdr

RECEIVING RECORD No. 3028053

RECEIVED BY: Oil Re-Refining Company EPA# WAD980986012 PLANT:PORTLAND
4150 N. Suttle Road Phone (503) 286-8352 EMPLOYEE:MRE
Portland, OR 97217 Fax (503) 286-5027 PAGE: 1

RECEIVED FROM: West Coast Marine Terra Hydr Customer ID# 78626903
3501 Thompson Ave Phone: 503-285-2485
DATE: 03/31/2004 Vancouver, WA 98660 Driver: KEITH

QTY. UNIT ITEM MNE. %H2O %SOLID B/L#
1. EACH Clor-D-Tect Kit N 75.0 0.0 0
GEN: West Coast Marine
CDT 100 PPM. PH 7. PROFILE ATTACHED. JOB# 10852.

TOTAL EAC 1.

300. GAL Emulsified Fuel N 75.0 %
GEN: PORT OF ASTORIA
CDT 100 PPM. PH 7. PROFILE ATTACHED. JOB# 10852.

TOTAL GAL 300.

Handwritten calculation: 300 gals ELF @ 35 = 10500.00
1 cdt @ 20.00 @ 99% = 198.00
Total: 10698.00

Customer warrants that the waste petroleum products being received do not contain any contaminants, including, without limitation, pesticides, chlorinated solvents at total concentrations greater than 1000 PPM, PCB's greater than 2 PPM, or any other material classified as hazardous waste by 40 CFR part 261, Subparts C and D (implementing the Federal Resource Conservation and Recovery Act) or by any State or local hazardous waste classification program. Should laboratory tests show this waste product not in compliance with 40 CFR part 261 customer agrees to pay for all disposal costs incurred.

Signed X

Handwritten signature

DATE: 03/31/2004

CONTAINS HAZARDOUS MATERIALS

THIS SHIPPING ORDER

must be legibly filled in, in ink, in indelible pencil, or in Carbon, and retained by the Agent

Shipper's No. ORV-10352

(Carrier) west coast marine

SCAC.

Carrier's No. WSDOT 490704

Received, subject to the classifications and tariffs in effect on the date of this Bill of Lading:

at Port of Astoria

date 033104

from Terra Hydr INC

the property described below, in apparent good order, except as noted (contents and condition of contents of packages unknown), marked, consigned, and delivered as indicated below, which said company (the word company being understood throughout this contract as meaning any person or corporation in possession of the property under the contract) agrees to carry to the usual place of delivery at said destination, if on his own road or his own water line, otherwise to deliver to another carrier on the route to said destination. It is mutually agreed, as to each carrier of all or any portion of said route to destination, and as to each party at any time interested in all or any of said property, that every service to be performed hereunder shall be subject to all the conditions not prohibited by law, whether printed or written, herein contained (as specified in Appendix B to Part 1035) which are hereby agreed to by the shipper and accepted for himself and his assignee.

(Mail or street address of consignee for purposes of notification only.)

TO: Oil RC-Resin
Consignee
Street
Destination Portland OR Zip

FROM: Terra Hydr
Shipper Port of Astoria
Street
Origin Astoria OR Zip

Route: I-5 / Hy-30

Delivering Carrier WCMC

Trailer Weight/Number 132

U.S. DOT Hazard Reg. Number 490704

No. of packages	HM	Description of articles, special marks, and exceptions	Hazard Class	I.D. Number	Packing Group	*Weight (subject to correction)	Class or rate	Labels required (or exemption)	Check column
I	X	Flammable Liquid N.O.S. gasoline (3 JUN 1993.) for Sp. 11 See guide # 128	3	1493	II	300 gal	gal	N/A	N/A

Remit C.O.D. to:
Address:
City:

State: N/A
Zip: N/A

COD AMT:
\$ N/A

Subject to Section 7 of conditions, if this shipment is to be delivered to the consignee without recourse on the consignor, the consignor shall sign the following statement: The carrier shall not make delivery of this shipment without payment of freight and all other lawful charges.

C. O. D. FEE:
Prepaid
Collect

Charges Advanced
\$

(Signature of consignor)

FREIGHT CHARGES
 Prepaid Collect

If the shipment moves between two ports by a carrier by water, the law requires that the Bill of Lading shall state whether it is "tonnage or shipment weight," when the rate is dependent on volume, shippers are required to state specifically in writing the agreed or declared value of the property. The agreed or declared value of the property is hereby specifically stated by the shipper to be not exceeding \$ per

This is to certify that the above-stated material is property classified, described, packaged, marked and labeled, and is in proper condition for transportation, according to the applicable regulations of the Department of Transportation.

PLACARDS REQUIRED

yes

PLACARDS SUPPLIED

YES NO - FURNISHED BY CARRIER
DRIVER'S SIGNATURE: Robert Baker

SHIPPER: Terra Hydr
PER: Jack Brown

DATE: 033104

CARRIER: west coast marine
PER: Robert Baker

DATE: 033103

EMERGENCY RESPONSE
TELEPHONE NUMBER: (503) 285-2485

*Permanent post office address of shipper

Monitored at all times, the Hazardous Material is in transportation including storage incidental to transportation (5172.804).

**APPENDIX B
PHOTOGRAPHS**



Photograph 1 - Concrete vault at EX-1 containing 6-inch-diameter piping and gate valves (view to north).

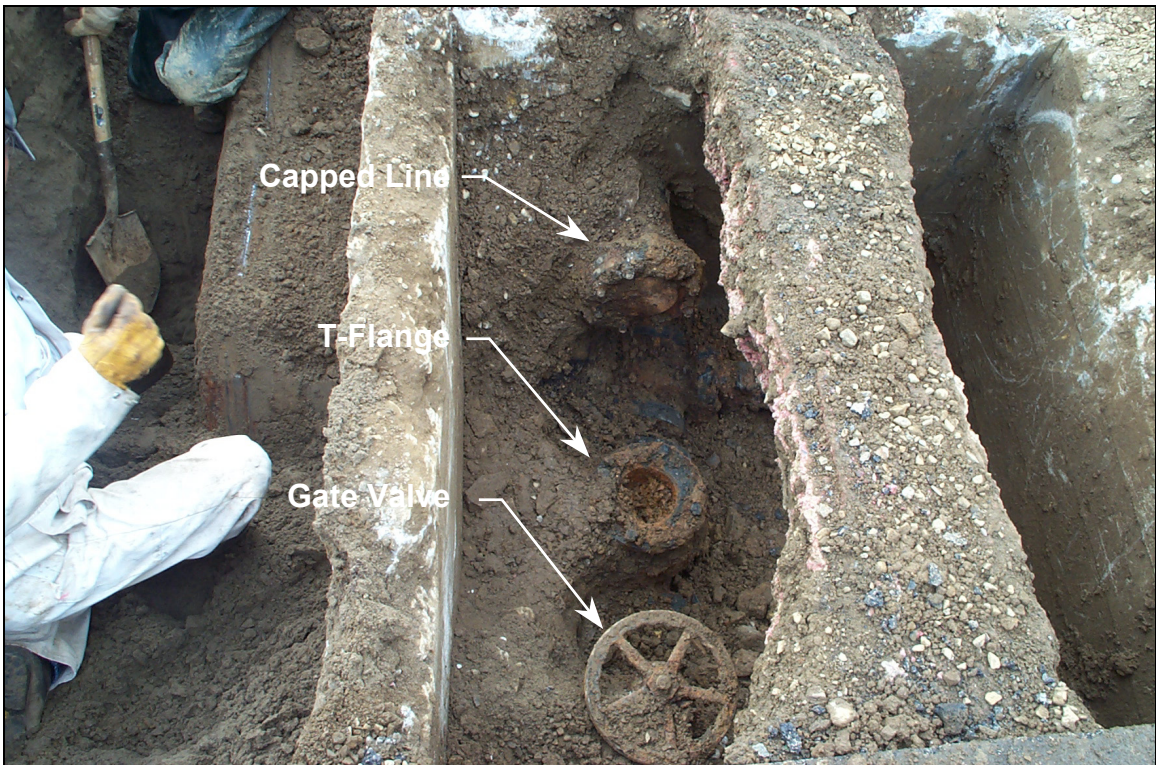

Photograph 2 - EX-1 piping configuration with off-loading product line gate valve, exposed T-flange, and capped former Shell bulk plant supply line (view to south).



Photograph 3 - Close-up of capped Shell bulk plant supply line and Niemi/Mobil bulk plant supply line with damaged gate valve.



Photograph 4 - EX-2 location showing 90° bend in former Niemi/Mobil bulk plant supply line.



Photograph 5 - EX-3 location showing one 3-inch-diameter product line and the 6-inch-diameter product line with 90° flange joints.



Photograph 6 - EX-3 location showing one 3-inch-diameter product line, the 6-inch-diameter product line with 90° flange joints, and an abandoned electrical conduit.

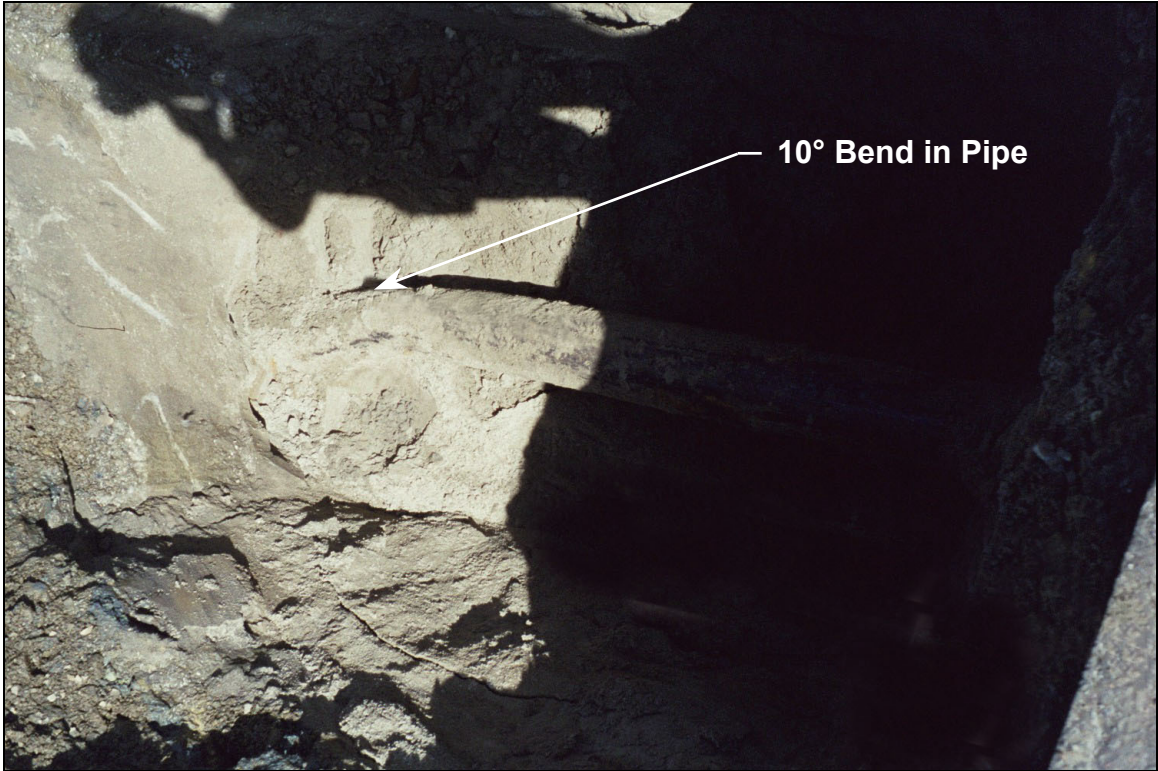

Photograph 7 - EX-4 location showing 6-inch-diameter product off-loading pipe with 10° bend. Concrete footing present at left side of photograph.



Photograph 8 - Draining accumulated water from 6-inch-diameter pipe exposed in EX-2.



Photograph 9 - Adding grout to 6-inch-diameter pipeline at EX-2.



Photograph 10 - Grout seal completed at EX-2.



Photograph 11 - Vapor screening 6-inch-diameter pipeline in EX-3.



Photograph 12 - Access holes cut in 3-inch-diameter and 6-inch-diameter pipelines in EX-3.



Photograph 13 - Vacuuming emulsified water/product from 6-inch-diameter product line at EX-3.



Photograph 14 - Compacting excavation backfill using a vibratory compactor.



Photograph 15 - Concrete placement in EX-1 vault.



Photograph 16 - Concrete placement in EX-1 vault complete.

APPENDIX C
QUALITY ASSURANCE REVIEW AND
ANALYTICAL LABORATORY DOCUMENTATION

APPENDIX C

QUALITY ASSURANCE REVIEW AND LABORATORY DOCUMENTATION

This appendix documents the results of a quality assurance (QA) review of the analytical data for samples collected during the pipeline investigation activities at the site. North Creek Analytical (NCA) in Beaverton, Oregon, performed the chemical analyses. Copies of the analytical laboratory reports are included with this appendix.

The QA review included examination and validation of the laboratory's summary reports, including the following:

- Analytical methods;
- Reporting limits;
- Sample holding times;
- Custody records;
- Surrogates, spikes, and blanks; and
- Duplicates.

ANALYTICAL METHODS AND SAMPLE MANAGEMENT

Chemical Analyses and Methods

All submitted soil samples were analyzed for total petroleum hydrocarbon (TPH) identification by Northwest Methodology NWTPH-HCID; and/or gasoline range petroleum hydrocarbons (TPH-Gx) by Northwest Method TPH-Gx and diesel to heavy oil range petroleum hydrocarbons (TPH-Dx) by Northwest Method TPH-Dx. Selected soil samples were analyzed for benzene, toluene, ethylbenzene, and total xylenes (BTEX) by EPA Method 8021B; and for polynuclear aromatic hydrocarbons (PAHs) by EPA Method 8270-SIM.

Sample Management

The analytical laboratory provided clean sample containers ready for sample collection. A sample label was affixed to each sample container and marked with a unique sample number, date of collection, project number, and sampler's initials. Samples were placed in a cooler with ice for field storage and transport to the laboratory. Chain of custody was maintained and documented throughout the sample management process. NCA received five soil samples on

April 1, 2004 (NCA Work Order No. P4D0071) and five soil samples on April 2, 2004 (NCA Work Order No. P4D0124). The following sample management anomalies were identified related to this work order: There were no anomalies encountered during the sample management process.

QUALITY ASSURANCE OBJECTIVES AND REVIEW

The general QA objectives for this project are to develop and implement procedures for obtaining and evaluating data of a specified quality that can be used to assess the site conditions and assess risk to human health and the environment. To collect such information, analytical data must have an appropriate degree of accuracy and reproducibility, samples collected must be representative of actual field conditions, and samples must be collected and analyzed using unbroken chain of custody procedures.

Reporting limits and analytical results are used to assess the quantity of each chemical of concern in media. Precision, accuracy, representativeness, completeness, and comparability parameters are used to evaluate data quality. These parameters are defined and discussed below.

Reporting Limits

Reporting limits are determined by the laboratory and are based on instrumentation capabilities, sample matrix, and EPA and Oregon Department of Environmental Quality (DEQ) method protocols. Reporting limits may be raised above standard limits due to high concentrations of analytes, matrix interference, or high moisture content.

The reporting limits for PAH analyses in samples EX-3/S-1 and SB-915(S)-5.0 were raised due to dilution. However, the elevated reporting limits are below the applicable generic Risk-Based Decision Making (RBDM) Risk-Based Concentrations (RBCs), thus these data are acceptable for the purposes of this project.

Holding Times

Sample collection dates are documented on the chain of custody forms. Collection, preparation/extraction, and analysis dates are indicated in the laboratory reports. Holding times required by DEQ and EPA protocols were met for all analyses performed on the submitted samples except for BTEX analysis. The reported BTEX analysis was performed outside of holding time due to low analyte (EX-4/S-1) or low surrogate (EX-1/S-1, EX-2/S-1, EX-3/S-1) recoveries in the initial analysis. The data are suitable for the purposes of this project and are not

flagged because the analysis was performed within 28 days (twice the recommended holding time period) of the sample collection date. However, the holding time exceedence has been noted in the data tables.

The extraction for PAH analysis on sample EX-4/S-1 was performed outside of the EPA recommended holding time. The data are suitable for the purposes of this project; however, the holding time exceedence has been noted in the data tables.

Accuracy

Accuracy is the measure of error between the reported test results and the true sample concentration. "Perfect" accuracy is 100 percent recovery. True sample concentration is never known due to analytical limitations and error. Consequently, accuracy is inferred from the recovery data from surrogates, matrix spike samples, and laboratory samples.

Surrogates. In a surrogate analysis, a known amount of a compound similar to the constituent of interest is added to the sample and measured. The surrogate analysis assesses the accuracy of a chemical measurement by comparing the measured value to the actual spiked value. This comparison is expressed as percent recovery. Surrogates were reported on all laboratory reports. All surrogates were within control limits except as noted below.

- The surrogate for TPH-Gx analysis associated with sample EX-1/S-1 was outside of control limits due to matrix interference. The associated batch data were within control limits and these data are acceptable.

Matrix Spike Samples. Matrix spike (MS) analyses are performed on samples submitted to the laboratory that are of the same matrix as the actual sample. The MS sample is spiked with known levels of the constituents of interest. These analyses are used to assess the potential for matrix interference with recovery or detection of the constituents of interest and the accuracy of the determination. The spiked sample results are compared to the expected result (i.e., sample concentration plus spike amount) and reported as percent recovery. All MS analyses were within control limits except as noted below.

- The MS sample for TPH-Gx analysis in the batch MS sample was outside of established control limits. The failure of a matrix spike QA sample does not represent an out of control condition for the batch and the associated batch data are acceptable.
- The MS and MS surrogate for BTEX analysis in the batch MS sample was outside of established control limits. The failure of a MS QA sample does

not represent an out of control condition for the batch and the associated batch data are acceptable.

Laboratory Control Samples. Laboratory control samples (LCS) are analyzed by the laboratory to assess the accuracy of the analytical equipment. The samples are prepared from an analyte-free matrix and are then spiked with known levels of the constituents of interest (i.e., a standard). The concentrations are measured and the results compared to the known spiked levels. This comparison is expressed as percent recovery. The percent recovery of laboratory control samples were within acceptability criteria for all analyses.

Precision

Precision measures the reproducibility of data under a given set of conditions. Specifically, it is a quantitative measure of the variability of a group of measurements compared to their average values. Analytical precision is measured by preparing and analyzing duplicate samples and comparing the original and duplicate sample results to assess the precision of the analytical method. This comparison is quantitatively expressed as the relative percent difference (RPD).

Matrix Spike Duplicates. In addition to the MS sample, a duplicate matrix spike sample (MSD) is prepared as described in the above section and analyzed. This is compared to the MS to assess the precision of the analytical method (i.e., RPD). All RPDs were within control limits except for the following:

- The MSD and MSD surrogate for BTEX analysis in the batch MS sample was outside of established control limits. The failure of a MS QA sample does not represent an out of control condition for the batch and the associated batch data are acceptable.

Laboratory Duplicates. A duplicate is a second laboratory sample taken from a submitted sample. The duplicate is then prepared along with the original. It is analyzed and compared to the first to assess the precision of the analytical method and the potential variability of the sample matrix. RPDs for the laboratory duplicates were within control limits.

Laboratory Control Sample Duplicates. In addition to the LCS, a duplicate LCS (LCS Dup) is prepared and analyzed. This is compared to the laboratory control sample to assess the precision of the analytical method (i.e., RPD). All RPDs were within control limits.

Representativeness

Representativeness is a measure of how closely the results reflect the actual concentration of the chemical parameters in the medium sampled. Sampling procedures, as well as sample-handling protocols for storage, preservation, and transportation are designed to preserve the representativeness of the samples collected. Field, trip, and laboratory method blanks are run in accordance with established laboratory protocols. No target compounds were detected in the field, trip, or laboratory method blanks.

Completeness

Completeness is defined as the percentage of measurements made which are judged to be valid measurements. The completeness of the data is the number of acceptable data points divided by the total number of data points multiplied by 100. The completeness goal is essentially that a sufficient amount of valid data be generated to allow for the evaluation of the site investigation.

The data collected during the site investigation are acceptable for the purposes of this investigation. Therefore, the completeness is 100 percent.

Comparability

Comparability is a qualitative parameter expressing the confidence with which one data set can be compared with another. All samples from this and previous investigations were analyzed in accordance with accepted methods of the EPA or DEQ. Because similar or the same methods were used, the quality of the data collected is consistent for all data sets, and the data sets are therefore comparable.

Conclusion

The overall quality assurance objectives have generally been met, and the resultant data are suitable for the purposes of this project.



HART CROWSER, INC.

APR 30 2004

Portland Office

Seattle 11720 North Creek Pkwy N, Suite 400, Bothell, WA 98011-9223
 425.420.9200 fax 425.420.9210
Spokane East 11115 Montgomery, Suite B, Spokane, WA 99206-4776
 509.924.9200 fax 509.924.9290
Portland 9405 SW Nimbus Avenue, Beaverton, OR 97008-7132
 503.906.9200 fax 503.906.9210
Bend 20332 Empire Avenue, Suite F-1, Bend, OR 97701-5711
 541.383.9310 fax 541.382.7588

Hart Crowser Five Centerpointe Drive Lake Oswego, OR 97035	Project: Astoria Area-Wide Petroleum Site Project Number: 15227 Project Manager: Leon Lahiere	Reported: 04/28/04 16:21
--	---	-----------------------------

ANALYTICAL REPORT FOR SAMPLES

Sample ID	Laboratory ID	Matrix	Date Sampled	Date Received
Ex-1/S-1	P4D0124-01	Soil	03/30/04 11:29	04/02/04 09:05
Ex-2/S-1	P4D0124-02	Soil	03/30/04 13:18	04/02/04 09:05
Ex-2/S-2	P4D0124-03	Soil	04/01/04 08:00	04/02/04 09:05
Ex-3/S-1	P4D0124-04	Soil	03/31/04 08:05	04/02/04 09:05
Ex-4/S-1	P4D0124-05	Soil	03/29/04 11:09	04/02/04 09:05

North Creek Analytical - Portland

Lisa Domenighini, Project Manager

The results in this report apply to the samples analyzed in accordance with the chain of custody document. This analytical report must be reproduced in its entirety.

North Creek Analytical, Inc.
Environmental Laboratory Network



Seattle 11720 North Creek Pkwy N, Suite 400, Bothell, WA 98011-9223
 425.420.9200 fax 425.420.9210
Spokane East 11115 Montgomery, Suite B, Spokane, WA 99206-4776
 509.924.9200 fax 509.924.9290
Portland 9405 SW Nimbus Avenue, Beaverton, OR 97008-7132
 503.906.9200 fax 503.906.9210
Bend 20332 Empire Avenue, Suite F-1, Bend, OR 97701-5711
 541.383.9310 fax 541.382.7588

Hart Crowser
 Five Centerpointe Drive
 Lake Oswego, OR 97035

Project: Astoria Area-Wide Petroleum Site
 Project Number: 15227
 Project Manager: Leon Lahiere

Reported:
 04/28/04 16:21

**Hydrocarbon Identification per NW-TPH Methodology
 North Creek Analytical - Portland**

Analyte	Result	Reporting Limit	Units	Dilution	Method	Prepared	Analyzed	Batch	Notes
Ex-4/S-1 (P4D0124-05) Soil						Sampled: 03/29/04 Received: 04/02/04			
Gasoline Range Hydrocarbons	ND	20.0	mg/kg dry	1	NWTPH HCID	04/06/04	04/06/04	4040182	
Diesel Range Hydrocarbons	ND	50.0	"	"	"	"	"	"	
Heavy Oil Range Hydrocarbons	ND	100	"	"	"	"	"	"	
<i>Surr: 1-Chlorooctadecane</i>	<i>111 %</i>	<i>50-150</i>							

North Creek Analytical - Portland

Lisa Domenighini, Project Manager

The results in this report apply to the samples analyzed in accordance with the chain of custody document. This analytical report must be reproduced in its entirety.

**North Creek Analytical, Inc.
 Environmental Laboratory Network**



Seattle 11720 North Creek Pkwy N, Suite 400, Bothell, WA 98011-9223
 425.420.9200 fax 425.420.9210
Spokane East 11115 Montgomery, Suite B, Spokane, WA 99206-4776
 509.924.9200 fax 509.924.9290
Portland 9405 SW Nimbus Avenue, Beaverton, OR 97008-7132
 503.906.9200 fax 503.906.9210
Bend 20332 Empire Avenue, Suite F-1, Bend, OR 97701-5711
 541.383.9310 fax 541.382.7588

Hart Crowser
 Five Centerpointe Drive
 Lake Oswego, OR 97035

Project: Astoria Area-Wide Petroleum Site
 Project Number: 15227
 Project Manager: Leon Lahiere

Reported:
 04/28/04 16:21

**Gasoline Hydrocarbons per NW TPH-Gx Method
 North Creek Analytical - Portland**

Analyte	Result	Reporting Limit	Units	Dilution	Method	Prepared	Analyzed	Batch	Notes
Ex-1/S-1 (P4D0124-01) Soil					Sampled: 03/30/04 Received: 04/02/04				
Gasoline Range Hydrocarbons	ND	4.00	mg/kg dry	1	NW TPH-Gx	04/06/04	04/07/04	4040217	
<i>Surr: a,a,a-TFT</i>	45.7 %	50-150							S-09
Ex-2/S-1 (P4D0124-02) Soil					Sampled: 03/30/04 Received: 04/02/04				
Gasoline Range Hydrocarbons	ND	4.00	mg/kg dry	1	NW TPH-Gx	04/06/04	04/07/04	4040217	
<i>Surr: a,a,a-TFT</i>	63.2 %	50-150							
Ex-2/S-2 (P4D0124-03) Soil					Sampled: 04/01/04 Received: 04/02/04				
Gasoline Range Hydrocarbons	ND	4.00	mg/kg dry	1	NW TPH-Gx	04/06/04	04/07/04	4040217	
<i>Surr: a,a,a-TFT</i>	62.4 %	50-150							
Ex-3/S-1 (P4D0124-04) Soil					Sampled: 03/31/04 Received: 04/02/04				
Gasoline Range Hydrocarbons	ND	4.00	mg/kg dry	1	NW TPH-Gx	04/06/04	04/07/04	4040217	
<i>Surr: a,a,a-TFT</i>	62.7 %	50-150							

North Creek Analytical - Portland

Lisa Domenighini, Project Manager

The results in this report apply to the samples analyzed in accordance with the chain of custody document. This analytical report must be reproduced in its entirety.

**North Creek Analytical, Inc.
 Environmental Laboratory Network**



Seattle 11720 North Creek Pkwy N, Suite 400, Bothell, WA 98011-9223
 425.420.9200 fax 425.420.9210
Spokane East 11115 Montgomery, Suite B, Spokane, WA 99206-4776
 509.924.9200 fax 509.924.9290
Portland 9405 SW Nimbus Avenue, Beaverton, OR 97008-7132
 503.906.9200 fax 503.906.9210
Bend 20332 Empire Avenue, Suite F-1, Bend, OR 97701-5711
 541.383.9310 fax 541.382.7588

Hart Crowser
 Five Centerpointe Drive
 Lake Oswego, OR 97035

Project: Astoria Area-Wide Petroleum Site
 Project Number: 15227
 Project Manager: Leon Lahiere

Reported:
 04/28/04 16:21

**Diesel and Heavy Range Hydrocarbons per NWTPH-Dx Method
 North Creek Analytical - Portland**

Analyte	Result	Reporting Limit	Units	Dilution	Method	Prepared	Analyzed	Batch	Notes
Ex-1/S-1 (P4D0124-01) Soil					Sampled: 03/30/04 Received: 04/02/04				
Diesel Range Organics	26.5	25.0	mg/kg dry	1	NWTPH-Dx	04/06/04	04/06/04	4040184	D-17
Heavy Oil Range Hydrocarbons	ND	50.0	"	"	"	"	"	"	
<i>Surr: 1-Chlorooctadecane</i>	114 %	50-150							
Ex-2/S-1 (P4D0124-02) Soil					Sampled: 03/30/04 Received: 04/02/04				
Diesel Range Organics	ND	25.0	mg/kg dry	1	NWTPH-Dx	04/06/04	04/06/04	4040184	
Heavy Oil Range Hydrocarbons	110	50.0	"	"	"	"	"	"	
<i>Surr: 1-Chlorooctadecane</i>	107 %	50-150							
Ex-2/S-2 (P4D0124-03) Soil					Sampled: 04/01/04 Received: 04/02/04				
Diesel Range Organics	ND	25.0	mg/kg dry	1	NWTPH-Dx	04/06/04	04/07/04	4040184	
Heavy Oil Range Hydrocarbons	ND	50.0	"	"	"	"	"	"	
<i>Surr: 1-Chlorooctadecane</i>	88.8 %	50-150							
Ex-3/S-1 (P4D0124-04) Soil					Sampled: 03/31/04 Received: 04/02/04				
Diesel Range Organics	770	125	mg/kg dry	5	NWTPH-Dx	04/06/04	04/07/04	4040184	A-01
Heavy Oil Range Hydrocarbons	760	250	"	"	"	"	"	"	A-01
<i>Surr: 1-Chlorooctadecane</i>	97.7 %	50-150							

North Creek Analytical - Portland

Lisa Domenighini, Project Manager

The results in this report apply to the samples analyzed in accordance with the chain of custody document. This analytical report must be reproduced in its entirety.



Seattle 11720 North Creek Pkwy N, Suite 400, Bothell, WA 98011-9223
425.420.9200 fax 425.420.9210
Spokane East 11115 Montgomery, Suite B, Spokane, WA 99206-4776
509.924.9200 fax 509.924.9290
Portland 9405 SW Nimbus Avenue, Beaverton, OR 97008-7132
503.906.9200 fax 503.906.9210
Bend 20332 Empire Avenue, Suite F-1, Bend, OR 97701-5711
541.383.9310 fax 541.382.7588

Hart Crowser
Five Centerpointe Drive
Lake Oswego, OR 97035

Project: Astoria Area-Wide Petroleum Site
Project Number: 15227
Project Manager: Leon Lahiere

Reported:
04/28/04 16:21

BTEX per EPA Method 8021B
North Creek Analytical - Portland

Analyte	Result	Reporting Limit	Units	Dilution	Method	Prepared	Analyzed	Batch	Notes
Ex-1/S-1 (P4D0124-01RE1) Soil						Sampled: 03/30/04 Received: 04/02/04			
Benzene	ND	0.0500	mg/kg dry	1	EPA 8021B	04/12/04	04/23/04	4040846	A-05a
Toluene	ND	0.0500	"	"	"	"	"	"	A-05a
Ethylbenzene	ND	0.0500	"	"	"	"	"	"	A-05a
Xylenes (total)	ND	0.0500	"	"	"	"	"	"	A-05a
<i>Surr: a,a,a-TFT (PID)</i>	57.0 %	70-130							A-05a
Ex-2/S-1 (P4D0124-02RE1) Soil						Sampled: 03/30/04 Received: 04/02/04			
Benzene	ND	0.0500	mg/kg dry	1	EPA 8021B	04/12/04	04/27/04	4040846	A-05a
Toluene	0.0530	0.0500	"	"	"	"	"	"	A-05a
Ethylbenzene	0.0778	0.0500	"	"	"	"	"	"	A-05a
Xylenes (total)	0.129	0.0500	"	"	"	"	"	"	A-05a
<i>Surr: a,a,a-TFT (PID)</i>	77.2 %	70-130							A-05a
Ex-3/S-1 (P4D0124-04RE1) Soil						Sampled: 03/31/04 Received: 04/02/04			
Benzene	ND	0.0500	mg/kg dry	1	EPA 8021B	04/12/04	04/23/04	4040846	A-05a
Toluene	ND	0.0500	"	"	"	"	"	"	A-05a
Ethylbenzene	ND	0.0500	"	"	"	"	"	"	A-05a
Xylenes (total)	ND	0.0500	"	"	"	"	"	"	A-05a
<i>Surr: a,a,a-TFT (PID)</i>	78.5 %	70-130							A-05a
Ex-4/S-1 (P4D0124-05RE1) Soil						Sampled: 03/29/04 Received: 04/02/04			
Benzene	ND	0.0500	mg/kg dry	1	EPA 8021B	04/12/04	04/23/04	4040846	A-05
Toluene	ND	0.0500	"	"	"	"	"	"	A-05
Ethylbenzene	ND	0.0500	"	"	"	"	"	"	A-05
Xylenes (total)	ND	0.0500	"	"	"	"	"	"	A-05
<i>Surr: a,a,a-TFT (PID)</i>	73.6 %	70-130							A-05

North Creek Analytical - Portland

Lisa Domenighini, Project Manager

The results in this report apply to the samples analyzed in accordance with the chain of custody document. This analytical report must be reproduced in its entirety.

North Creek Analytical, Inc.
Environmental Laboratory Network

Page 5 of 18



Seattle 11720 North Creek Pkwy N, Suite 400, Bothell, WA 98011-9223
 425.420.9200 fax 425.420.9210
Spokane East 11115 Montgomery, Suite B, Spokane, WA 99206-4776
 509.924.9200 fax 509.924.9290
Portland 9405 SW Nimbus Avenue, Beaverton, OR 97008-7132
 503.906.9200 fax 503.906.9210
Bend 20332 Empire Avenue, Suite F-1, Bend, OR 97701-5711
 541.383.9310 fax 541.382.7588

Hart Crowser
 Five Centerpointe Drive
 Lake Oswego, OR 97035

Project: Astoria Area-Wide Petroleum Site
 Project Number: 15227
 Project Manager: Leon Lahiere

Reported:
 04/28/04 16:21

Polynuclear Aromatic Compounds per EPA 8270M-SIM
North Creek Analytical - Portland

Analyte	Result	Reporting Limit	Units	Dilution	Method	Prepared	Analyzed	Batch	Notes
Ex-1/S-1 (P4D0124-01) Soil						Sampled: 03/30/04 Received: 04/02/04			
Acenaphthene	ND	13.4	ug/kg dry	1	EPA 8270m	04/13/04	04/19/04	4040462	
Acenaphthylene	ND	13.4	"	"	"	"	"	"	
Anthracene	ND	13.4	"	"	"	"	"	"	
Benzo (a) anthracene	ND	13.4	"	"	"	"	"	"	
Benzo (a) pyrene	ND	13.4	"	"	"	"	"	"	
Benzo (b) fluoranthene	ND	13.4	"	"	"	"	"	"	
Benzo (ghi) perylene	ND	13.4	"	"	"	"	"	"	
Benzo (k) fluoranthene	ND	13.4	"	"	"	"	"	"	
Chrysene	ND	13.4	"	"	"	"	"	"	
Dibenzo (a,h) anthracene	ND	13.4	"	"	"	"	"	"	
Fluoranthene	ND	13.4	"	"	"	"	"	"	
Fluorene	ND	13.4	"	"	"	"	"	"	
Indeno (1,2,3-cd) pyrene	ND	13.4	"	"	"	"	"	"	
Naphthalene	ND	13.4	"	"	"	"	"	"	
Phenanthrene	ND	13.4	"	"	"	"	"	"	
Pyrene	ND	13.4	"	"	"	"	"	"	
<i>Surr: Fluorene-d10</i>	78.1 %	40-150							
<i>Surr: Pyrene-d10</i>	106 %	40-150							
<i>Surr: Benzo (a) pyrene-d12</i>	82.4 %	40-150							

Ex-2/S-1 (P4D0124-02) Soil						Sampled: 03/30/04 Received: 04/02/04			
Acenaphthene	ND	13.4	ug/kg dry	1	EPA 8270m	04/13/04	04/19/04	4040462	
Acenaphthylene	ND	13.4	"	"	"	"	"	"	
Anthracene	ND	13.4	"	"	"	"	"	"	
Benzo (a) anthracene	ND	13.4	"	"	"	"	"	"	
Benzo (a) pyrene	ND	13.4	"	"	"	"	"	"	
Benzo (b) fluoranthene	ND	13.4	"	"	"	"	"	"	
Benzo (ghi) perylene	18.4	13.4	"	"	"	"	"	"	
Benzo (k) fluoranthene	ND	13.4	"	"	"	"	"	"	
Chrysene	ND	13.4	"	"	"	"	"	"	
Dibenzo (a,h) anthracene	ND	13.4	"	"	"	"	"	"	
Fluoranthene	ND	13.4	"	"	"	"	"	"	
Fluorene	ND	13.4	"	"	"	"	"	"	
Indeno (1,2,3-cd) pyrene	ND	13.4	"	"	"	"	"	"	
Naphthalene	35.2	13.4	"	"	"	"	"	"	
Phenanthrene	ND	13.4	"	"	"	"	"	"	
Pyrene	16.2	13.4	"	"	"	"	"	"	
<i>Surr: Fluorene-d10</i>	82.3 %	40-150							

North Creek Analytical - Portland

The results in this report apply to the samples analyzed in accordance with the chain of custody document. This analytical report must be reproduced in its entirety.

Lisa Domenighini, Project Manager

North Creek Analytical, Inc.
Environmental Laboratory Network



Seattle 11720 North Creek Pkwy N, Suite 400, Bothell, WA 98011-9223
 425.420.9200 fax 425.420.9210
Spokane East 11115 Montgomery, Suite B, Spokane, WA 99206-4776
 509.924.9200 fax 509.924.9290
Portland 9405 SW Nimbus Avenue, Beaverton, OR 97008-7132
 503.906.9200 fax 503.906.9210
Bend 20332 Empire Avenue, Suite F-1, Bend, OR 97701-5711
 541.383.9310 fax 541.382.7588

Hart Crowser Five Centerpointe Drive Lake Oswego, OR 97035	Project: Astoria Area-Wide Petroleum Site Project Number: 15227 Project Manager: Leon Lahiere	Reported: 04/28/04 16:21
--	---	-----------------------------

**Polynuclear Aromatic Compounds per EPA 8270M-SIM
 North Creek Analytical - Portland**

Analyte	Result	Reporting Limit	Units	Dilution	Method	Prepared	Analyzed	Batch	Notes
---------	--------	-----------------	-------	----------	--------	----------	----------	-------	-------

Ex-2/S-1 (P4D0124-02) Soil						Sampled: 03/30/04 Received: 04/02/04			
<i>Surr: Pyrene-d10</i>	101 %	40-150							
<i>Surr: Benzo (a) pyrene-d12</i>	83.9 %	40-150							

Ex-3/S-1 (P4D0124-04) Soil						Sampled: 03/31/04 Received: 04/02/04			R-05
Acenaphthene	ND	67.0	ug/kg dry	5	EPA 8270m	04/13/04	04/19/04	4040462	
Acenaphthylene	ND	67.0	"	"	"	"	"	"	
Anthracene	ND	67.0	"	"	"	"	"	"	
Benzo (a) anthracene	96.7	67.0	"	"	"	"	"	"	
Benzo (a) pyrene	102	67.0	"	"	"	"	"	"	
Benzo (b) fluoranthene	94.1	67.0	"	"	"	"	"	"	
Benzo (ghi) perylene	89.0	67.0	"	"	"	"	"	"	
Benzo (k) fluoranthene	ND	67.0	"	"	"	"	"	"	
Chrysene	106	67.0	"	"	"	"	"	"	
Dibenzo (a,h) anthracene	ND	67.0	"	"	"	"	"	"	
Fluoranthene	152	67.0	"	"	"	"	"	"	
Fluorene	ND	67.0	"	"	"	"	"	"	
Indeno (1,2,3-cd) pyrene	ND	67.0	"	"	"	"	"	"	
Naphthalene	ND	67.0	"	"	"	"	"	"	
Phenanthrene	86.2	67.0	"	"	"	"	"	"	
Pyrene	194	67.0	"	"	"	"	"	"	
<i>Surr: Fluorene-d10</i>	74.2 %	40-150							
<i>Surr: Pyrene-d10</i>	102 %	40-150							
<i>Surr: Benzo (a) pyrene-d12</i>	79.7 %	40-150							

Ex-4/S-1 (P4D0124-05) Soil						Sampled: 03/29/04 Received: 04/02/04			O-07
Acenaphthene	ND	13.4	ug/kg dry	1	EPA 8270m	04/13/04	04/16/04	4040462	
Acenaphthylene	ND	13.4	"	"	"	"	"	"	
Anthracene	ND	13.4	"	"	"	"	"	"	
Benzo (a) anthracene	ND	13.4	"	"	"	"	"	"	
Benzo (a) pyrene	ND	13.4	"	"	"	"	"	"	
Benzo (b) fluoranthene	ND	13.4	"	"	"	"	"	"	
Benzo (ghi) perylene	ND	13.4	"	"	"	"	"	"	
Benzo (k) fluoranthene	ND	13.4	"	"	"	"	"	"	
Chrysene	ND	13.4	"	"	"	"	"	"	
Dibenzo (a,h) anthracene	ND	13.4	"	"	"	"	"	"	
Fluoranthene	ND	13.4	"	"	"	"	"	"	
Fluorene	ND	13.4	"	"	"	"	"	"	
Indeno (1,2,3-cd) pyrene	ND	13.4	"	"	"	"	"	"	

North Creek Analytical - Portland

The results in this report apply to the samples analyzed in accordance with the chain of custody document. This analytical report must be reproduced in its entirety.

Lisa Domenighini, Project Manager

North Creek Analytical, Inc.
Environmental Laboratory Network



Seattle 11720 North Creek Pkwy N, Suite 400, Bothell, WA 98011-9223
 425.420.9200 fax 425.420.9210
Spokane East 11115 Montgomery, Suite B, Spokane, WA 99206-4776
 509.924.9200 fax 509.924.9290
Portland 9405 SW Nimbus Avenue, Beaverton, OR 97008-7132
 503.906.9200 fax 503.906.9210
Bend 20332 Empire Avenue, Suite F-1, Bend, OR 97701-5711
 541.383.9310 fax 541.382.7588

Hart Crowser
 Five Centerpointe Drive
 Lake Oswego, OR 97035

Project: Astoria Area-Wide Petroleum Site
 Project Number: 15227
 Project Manager: Leon Lahiere

Reported:
 04/28/04 16:21

Polynuclear Aromatic Compounds per EPA 8270M-SIM
North Creek Analytical - Portland

Analyte	Result	Reporting Limit	Units	Dilution	Method	Prepared	Analyzed	Batch	Notes	
Ex-4/S-1 (P4D0124-05) Soil						Sampled: 03/29/04		Received: 04/02/04		O-07
Naphthalene	ND	13.4	ug/kg dry	1	EPA 8270m	04/13/04	04/16/04	4040462		
Phenanthrene	ND	13.4	"	"	"	"	"	"		
Pyrene	ND	13.4	"	"	"	"	"	"		
<i>Surr: Fluorene-d10</i>	71.3 %	40-150								
<i>Surr: Pyrene-d10</i>	92.7 %	40-150								
<i>Surr: Benzo (a) pyrene-d12</i>	76.4 %	40-150								

North Creek Analytical - Portland

Lisa Domenighini, Project Manager

The results in this report apply to the samples analyzed in accordance with the chain of custody document. This analytical report must be reproduced in its entirety.

North Creek Analytical, Inc.
Environmental Laboratory Network



Seattle 11720 North Creek Pkwy N, Suite 400, Bothell, WA 98011-9223
 425.420.9200 fax 425.420.9210
Spokane East 11115 Montgomery, Suite B, Spokane, WA 99206-4776
 509.924.9200 fax 509.924.9290
Portland 9405 SW Nimbus Avenue, Beaverton, OR 97008-7132
 503.906.9200 fax 503.906.9210
Bend 20332 Empire Avenue, Suite F-1, Bend, OR 97701-5711
 541.383.9310 fax 541.382.7588

Hart Crowser
 Five Centerpointe Drive
 Lake Oswego, OR 97035

Project: Astoria Area-Wide Petroleum Site
 Project Number: 15227
 Project Manager: Leon Lahiere

Reported:
 04/28/04 16:21

**Percent Dry Weight (Solids) per Standard Methods
 North Creek Analytical - Portland**

Analyte	Result	Reporting Limit	Units	Dilution	Method	Prepared	Analyzed	Batch	Notes
Ex-1/S-1 (P4D0124-01) Soil						Sampled: 03/30/04 Received: 04/02/04			
% Solids	90.7	1.00	% by Weight	1	NCA SOP	04/07/04	04/08/04	4040273	
Ex-2/S-1 (P4D0124-02) Soil						Sampled: 03/30/04 Received: 04/02/04			
% Solids	91.8	1.00	% by Weight	1	NCA SOP	04/07/04	04/08/04	4040273	
Ex-2/S-2 (P4D0124-03) Soil						Sampled: 04/01/04 Received: 04/02/04			
% Solids	89.5	1.00	% by Weight	1	NCA SOP	04/07/04	04/08/04	4040273	
Ex-3/S-1 (P4D0124-04) Soil						Sampled: 03/31/04 Received: 04/02/04			
% Solids	92.3	1.00	% by Weight	1	NCA SOP	04/07/04	04/08/04	4040273	
Ex-4/S-1 (P4D0124-05) Soil						Sampled: 03/29/04 Received: 04/02/04			
% Solids	78.6	1.00	% by Weight	1	NCA SOP	04/07/04	04/08/04	4040273	

North Creek Analytical - Portland

Lisa Domenighini, Project Manager

The results in this report apply to the samples analyzed in accordance with the chain of custody document. This analytical report must be reproduced in its entirety.



Seattle 11720 North Creek Pkwy N, Suite 400, Bothell, WA 98011-9223
 425.420.9200 fax 425.420.9210
Spokane East 11115 Montgomery, Suite B, Spokane, WA 99206-4776
 509.924.9200 fax 509.924.9290
Portland 9405 SW Nimbus Avenue, Beaverton, OR 97008-7132
 503.906.9200 fax 503.906.9210
Bend 20332 Empire Avenue, Suite F-1, Bend, OR 97701-5711
 541.383.9310 fax 541.382.7588

Hart Crowser Five Centerpointe Drive Lake Oswego, OR 97035	Project: Astoria Area-Wide Petroleum Site Project Number: 15227 Project Manager: Leon Lahiere	Reported: 04/28/04 16:21
--	---	-----------------------------

Hydrocarbon Identification per NW-TPH Methodology - Quality Control

North Creek Analytical - Portland

Analyte	Result	Reporting Limit	Units	Spike Level	Source Result	%REC	%REC Limits	RPD	RPD Limit	Notes
---------	--------	-----------------	-------	-------------	---------------	------	-------------	-----	-----------	-------

Batch 4040182 - TPH-HCID Extraction

Blank (4040182-BLK1)	Prepared & Analyzed: 04/06/04									
Gasoline Range Hydrocarbons	ND	20.0	mg/kg							
Diesel Range Hydrocarbons	ND	50.0	"							
Heavy Oil Range Hydrocarbons	ND	100	"							
<i>Surr: 1-Chlorooctadecane</i>	<i>DET</i>		<i>"</i>	<i>9.60</i>		<i>109</i>	<i>50-150</i>			

Duplicate (4040182-DUP1)	Source: P4D0125-02 Prepared & Analyzed: 04/06/04									
Gasoline Range Hydrocarbons	ND	20.0	mg/kg dry		18.6			6.67	50	
Diesel Range Hydrocarbons	DET	50.0	"		438			24.1	50	
Heavy Oil Range Hydrocarbons	DET	100	"		845			24.4	50	
<i>Surr: 1-Chlorooctadecane</i>	<i>DET</i>		<i>"</i>	<i>11.0</i>		<i>80.7</i>	<i>50-150</i>			

Duplicate (4040182-DUP2)	Source: P4D0125-03 Prepared & Analyzed: 04/06/04									
Gasoline Range Hydrocarbons	DET	20.0	mg/kg dry		5460			4.65	50	
Diesel Range Hydrocarbons	DET	50.0	"		12600			3.89	50	
Heavy Oil Range Hydrocarbons	DET	100	"		150			1.32	50	
<i>Surr: 1-Chlorooctadecane</i>	<i>DET</i>		<i>"</i>	<i>12.9</i>		<i>97.7</i>	<i>50-150</i>			

North Creek Analytical - Portland

Lisa Domenighini, Project Manager

The results in this report apply to the samples analyzed in accordance with the chain of custody document. This analytical report must be reproduced in its entirety.



Seattle 11720 North Creek Pkwy N, Suite 400, Bothell, WA 98011-9223
 425.420.9200 fax 425.420.9210
Spokane East 11115 Montgomery, Suite B, Spokane, WA 99206-4776
 509.924.9200 fax 509.924.9290
Portland 9405 SW Nimbus Avenue, Beaverton, OR 97008-7132
 503.906.9200 fax 503.906.9210
Bend 20332 Empire Avenue, Suite F-1, Bend, OR 97701-5711
 541.383.9310 fax 541.382.7588

Hart Crowser Five Centerpointe Drive Lake Oswego, OR 97035	Project: Astoria Area-Wide Petroleum Site Project Number: 15227 Project Manager: Leon Lahiere	Reported: 04/28/04 16:21
--	---	-----------------------------

Gasoline Hydrocarbons per NW TPH-Gx Method - Quality Control

North Creek Analytical - Portland

Analyte	Result	Reporting Limit	Units	Spike Level	Source Result	%REC	%REC Limits	RPD	RPD Limit	Notes
---------	--------	-----------------	-------	-------------	---------------	------	-------------	-----	-----------	-------

Batch 4040217 - EPA 5035

Blank (4040217-BLK1)				Prepared: 04/06/04 Analyzed: 04/07/04						
Gasoline Range Hydrocarbons	ND	4.00	mg/kg							
Surr: a,a,a-TFT	2.32		"	2.50		92.8	50-150			
LCS (4040217-BS1)				Prepared: 04/06/04 Analyzed: 04/07/04						
Gasoline Range Hydrocarbons	10.6	4.00	mg/kg	12.5		84.8	70-130			
Surr: a,a,a-TFT	2.41		"	2.50		96.4	50-150			
Duplicate (4040217-DUP1)				Source: P4D0124-01		Prepared: 04/06/04 Analyzed: 04/09/04				
Gasoline Range Hydrocarbons	ND	4.00	mg/kg dry		1.26			13.6	40	
Surr: a,a,a-TFT	1.39		"	2.76		50.4	50-150			
Duplicate (4040217-DUP2)				Source: P4D0128-07		Prepared: 04/06/04 Analyzed: 04/07/04				
Gasoline Range Hydrocarbons	ND	4.00	mg/kg dry		1.95			29.4	40	
Surr: a,a,a-TFT	2.06		"	3.38		60.9	50-150			
Matrix Spike (4040217-MS1)				Source: P4D0124-01		Prepared: 04/06/04 Analyzed: 04/09/04				
Gasoline Range Hydrocarbons	10.2	4.00	mg/kg dry	13.8	1.26	64.8	65-130			Q-01
Surr: a,a,a-TFT	1.22		"	2.76		44.2	50-150			S-09

North Creek Analytical - Portland

Lisa Domenighini, Project Manager

The results in this report apply to the samples analyzed in accordance with the chain of custody document. This analytical report must be reproduced in its entirety.

North Creek Analytical, Inc.
Environmental Laboratory Network

Page 11 of 18



Seattle 11720 North Creek Pkwy N, Suite 400, Bothell, WA 98011-9223
 425.420.9200 fax 425.420.9210
Spokane East 11115 Montgomery, Suite B, Spokane, WA 99206-4776
 509.924.9200 fax 509.924.9290
Portland 9405 SW Nimbus Avenue, Beaverton, OR 97008-7132
 503.906.9200 fax 503.906.9210
Bend 20332 Empire Avenue, Suite F-1, Bend, OR 97701-5711
 541.383.9310 fax 541.382.7588

Hart Crowser Five Centerpointe Drive Lake Oswego, OR 97035	Project: Astoria Area-Wide Petroleum Site Project Number: 15227 Project Manager: Leon Lahiere	Reported: 04/28/04 16:21
--	---	-----------------------------

Diesel and Heavy Range Hydrocarbons per NWTPH-Dx Method - Quality Control

North Creek Analytical - Portland

Analyte	Result	Reporting Limit	Units	Spike Level	Source Result	%REC	%REC Limits	RPD	RPD Limit	Notes
---------	--------	-----------------	-------	-------------	---------------	------	-------------	-----	-----------	-------

Batch 4040184 - EPA 3550 Fuels

Blank (4040184-BLK1) Prepared & Analyzed: 04/06/04

Diesel Range Organics	ND	25.0	mg/kg							
Heavy Oil Range Hydrocarbons	ND	50.0	"							
<i>Surr: 1-Chlorooctadecane</i>	3.65		"	4.80		76.0	50-150			

LCS (4040184-BS1) Prepared & Analyzed: 04/06/04

Diesel Range Organics	103	25.0	mg/kg	125		82.4	50-150			
Heavy Oil Range Hydrocarbons	54.3	50.0	"	75.0		72.4	50-150			
<i>Surr: 1-Chlorooctadecane</i>	4.99		"	4.80		104	50-150			

Duplicate (4040184-DUP1) Source: P4D0124-01 Prepared & Analyzed: 04/06/04

Diesel Range Organics	28.8	25.0	mg/kg dry		26.5			8.32	50	
Heavy Oil Range Hydrocarbons	ND	50.0	"		34.0			6.54	50	
<i>Surr: 1-Chlorooctadecane</i>	6.43		"	5.29		122	50-150			

Duplicate (4040184-DUP2) Source: P4D0124-02 Prepared & Analyzed: 04/06/04

Diesel Range Organics	ND	25.0	mg/kg dry		16.1				50	Q-16
Heavy Oil Range Hydrocarbons	ND	50.0	"		110			89.5	50	Q-16
<i>Surr: 1-Chlorooctadecane</i>	5.91		"	5.23		113	50-150			

North Creek Analytical - Portland

Lisa Domenighini, Project Manager

The results in this report apply to the samples analyzed in accordance with the chain of custody document. This analytical report must be reproduced in its entirety.



Seattle 11720 North Creek Pkwy N, Suite 400, Bothell, WA 98011-9223
425.420.9200 fax 425.420.9210
Spokane East 11115 Montgomery, Suite B, Spokane, WA 99206-4776
509.924.9200 fax 509.924.9290
Portland 9405 SW Nimbus Avenue, Beaverton, OR 97008-7132
503.906.9200 fax 503.906.9210
Bend 20332 Empire Avenue, Suite F-1, Bend, OR 97701-5711
541.383.9310 fax 541.382.7588

Hart Crowser Five Centerpointe Drive Lake Oswego, OR 97035	Project: Astoria Area-Wide Petroleum Site Project Number: 15227 Project Manager: Leon Lahiere	Reported: 04/28/04 16:21
--	---	-----------------------------

BTEX per EPA Method 8021B - Quality Control

North Creek Analytical - Portland

Analyte	Result	Reporting Limit	Units	Spike Level	Source Result	%REC	%REC Limits	RPD	RPD Limit	Notes
---------	--------	-----------------	-------	-------------	---------------	------	-------------	-----	-----------	-------

Batch 4040846 - EPA 5035

Blank (4040846-BLK1)		Prepared: 04/21/04 Analyzed: 04/22/04								
Benzene	ND	0.0500	mg/kg							
Toluene	ND	0.0500	"							
Ethylbenzene	ND	0.0500	"							
Xylenes (total)	ND	0.0500	"							
<i>Surr: a,a,a-TFT (PID)</i>	1.22		"	1.25		97.6	70-130			

LCS (4040846-BS1)		Prepared: 04/21/04 Analyzed: 04/22/04								
Benzene	1.17	0.0500	mg/kg	1.25		93.6	65-130			
Toluene	1.09	0.0500	"	1.25		87.2	65-130			
Ethylbenzene	1.19	0.0500	"	1.25		95.2	65-130			
Xylenes (total)	3.49	0.0500	"	3.75		93.1	65-130			
<i>Surr: a,a,a-TFT (PID)</i>	1.17		"	1.25		93.6	70-130			

Matrix Spike (4040846-MS1)		Source: P4D0107-06RE1		Prepared: 04/21/04 Analyzed: 04/22/04						
Benzene	1.02	0.0500	mg/kg dry	1.54	ND	66.2	65-130			
Toluene	0.977	0.0500	"	1.54	ND	63.4	65-130			Q-01
Ethylbenzene	1.11	0.0500	"	1.54	ND	72.1	65-130			
Xylenes (total)	3.33	0.0500	"	4.62	ND	72.1	65-130			
<i>Surr: a,a,a-TFT (PID)</i>	0.828		"	1.54		53.8	70-130			S-03

Matrix Spike Dup (4040846-MSD1)		Source: P4D0107-06RE1		Prepared: 04/21/04 Analyzed: 04/22/04						
Benzene	0.987	0.0500	mg/kg dry	1.54	ND	64.1	65-130	3.29	20	Q-01
Toluene	0.956	0.0500	"	1.54	ND	62.1	65-130	2.17	20	Q-01
Ethylbenzene	1.08	0.0500	"	1.54	ND	70.1	65-130	2.74	20	
Xylenes (total)	3.26	0.0500	"	4.62	ND	70.6	65-130	2.12	20	
<i>Surr: a,a,a-TFT (PID)</i>	0.768		"	1.54		49.9	70-130			S-03

North Creek Analytical - Portland

Lisa Domenighini, Project Manager

The results in this report apply to the samples analyzed in accordance with the chain of custody document. This analytical report must be reproduced in its entirety.

North Creek Analytical, Inc.
Environmental Laboratory Network



Seattle 11720 North Creek Pkwy N, Suite 400, Bothell, WA 98011-9223
425.420.9200 fax 425.420.9210
Spokane East 11115 Montgomery, Suite B, Spokane, WA 99206-4776
509.924.9200 fax 509.924.9290
Portland 9405 SW Nimbus Avenue, Beaverton, OR 97008-7132
503.906.9200 fax 503.906.9210
Bend 20332 Empire Avenue, Suite F-1, Bend, OR 97701-5711
541.383.9310 fax 541.382.7588

Hart Crowser Five Centerpointe Drive Lake Oswego, OR 97035	Project: Astoria Area-Wide Petroleum Site Project Number: 15227 Project Manager: Leon Lahiere	Reported: 04/28/04 16:21
--	---	-----------------------------

Polynuclear Aromatic Compounds per EPA 8270M-SIM - Quality Control

North Creek Analytical - Portland

Analyte	Result	Reporting Limit	Units	Spike Level	Source Result	%REC	%REC Limits	RPD	RPD Limit	Notes
---------	--------	-----------------	-------	-------------	---------------	------	-------------	-----	-----------	-------

Batch 4040462 - EPA 3550

Blank (4040462-BLK1) Prepared: 04/13/04 Analyzed: 04/16/04

Acenaphthene	ND	13.4	ug/kg							
Acenaphthylene	ND	13.4	"							
Anthracene	ND	13.4	"							
Benzo (a) anthracene	ND	13.4	"							
Benzo (a) pyrene	ND	13.4	"							
Benzo (b) fluoranthene	ND	13.4	"							
Benzo (ghi) perylene	ND	13.4	"							
Benzo (k) fluoranthene	ND	13.4	"							
Chrysene	ND	13.4	"							
Dibenzo (a,h) anthracene	ND	13.4	"							
Fluoranthene	ND	13.4	"							
Fluorene	ND	13.4	"							
Indeno (1,2,3-cd) pyrene	ND	13.4	"							
Naphthalene	ND	13.4	"							
Phenanthrene	ND	13.4	"							
Pyrene	ND	13.4	"							
Surr: Fluorene-d10	67.7		"	83.3		81.3	40-150			
Surr: Pyrene-d10	76.1		"	83.3		91.4	40-150			
Surr: Benzo (a) pyrene-d12	75.6		"	83.3		90.8	40-150			

LCS (4040462-BS1) Prepared: 04/13/04 Analyzed: 04/16/04

Acenaphthene	127	13.4	ug/kg	167		76.0	33-139			
Benzo (a) pyrene	150	13.4	"	167		89.8	45-149			
Pyrene	141	13.4	"	167		84.4	39-138			
Surr: Fluorene-d10	67.9		"	83.3		81.5	40-150			
Surr: Pyrene-d10	73.7		"	83.3		88.5	40-150			
Surr: Benzo (a) pyrene-d12	77.3		"	83.3		92.8	40-150			

North Creek Analytical - Portland

Lisa Domenighini, Project Manager

The results in this report apply to the samples analyzed in accordance with the chain of custody document. This analytical report must be reproduced in its entirety.



Seattle 11720 North Creek Pkwy N, Suite 400, Bothell, WA 98011-9223
425.420.9200 fax 425.420.9210
Spokane East 11115 Montgomery, Suite B, Spokane, WA 99206-4776
509.924.9200 fax 509.924.9290
Portland 9405 SW Nimbus Avenue, Beaverton, OR 97008-7132
503.906.9200 fax 503.906.9210
Bend 20332 Empire Avenue, Suite F-1, Bend, OR 97701-5711
541.383.9310 fax 541.382.7588

Hart Crowser Five Centerpointe Drive Lake Oswego, OR 97035	Project: Astoria Area-Wide Petroleum Site Project Number: 15227 Project Manager: Leon Lahiere	Reported: 04/28/04 16:21
--	---	-----------------------------

Polynuclear Aromatic Compounds per EPA 8270M-SIM - Quality Control

North Creek Analytical - Portland

Analyte	Result	Reporting Limit	Units	Spike Level	Source Result	%REC	%REC Limits	RPD	RPD Limit	Notes
---------	--------	-----------------	-------	-------------	---------------	------	-------------	-----	-----------	-------

Batch 4040462 - EPA 3550

Matrix Spike (4040462-MS1)	Source: P4D0124-02			Prepared: 04/13/04		Analyzed: 04/19/04				
Acenaphthene	142	13.4	ug/kg dry	182	ND	78.0	33-139			
Benzo (a) pyrene	157	13.4	"	182	9.73	80.9	45-149			
Pyrene	193	13.4	"	182	16.2	97.1	39-138			
<i>Surr: Fluorene-d10</i>	73.0		"	90.8		80.4	40-150			
<i>Surr: Pyrene-d10</i>	94.8		"	90.8		104	40-150			
<i>Surr: Benzo (a) pyrene-d12</i>	77.6		"	90.8		85.5	40-150			

Matrix Spike Dup (4040462-MSD1)	Source: P4D0124-02			Prepared: 04/13/04		Analyzed: 04/19/04				
Acenaphthene	151	13.4	ug/kg dry	182	ND	83.0	33-139	6.14	60	
Benzo (a) pyrene	175	13.4	"	182	9.73	90.8	45-149	10.8	60	
Pyrene	194	13.4	"	182	16.2	97.7	39-138	0.517	60	
<i>Surr: Fluorene-d10</i>	76.6		"	90.8		84.4	40-150			
<i>Surr: Pyrene-d10</i>	94.3		"	90.8		104	40-150			
<i>Surr: Benzo (a) pyrene-d12</i>	86.0		"	90.8		94.7	40-150			

North Creek Analytical - Portland

Lisa Domenighini, Project Manager

The results in this report apply to the samples analyzed in accordance with the chain of custody document. This analytical report must be reproduced in its entirety.



Seattle 11720 North Creek Pkwy N, Suite 400, Bothell, WA 98011-9223
 425.420.9200 fax 425.420.9210
Spokane East 11115 Montgomery, Suite B, Spokane, WA 99206-4776
 509.924.9200 fax 509.924.9290
Portland 9405 SW Nimbus Avenue, Beaverton, OR 97008-7132
 503.906.9200 fax 503.906.9210
Bend 20332 Empire Avenue, Suite F-1, Bend, OR 97701-5711
 541.383.9310 fax 541.382.7588

Hart Crowser Five Centerpointe Drive Lake Oswego, OR 97035	Project: Astoria Area-Wide Petroleum Site Project Number: 15227 Project Manager: Leon Lahiere	Reported: 04/28/04 16:21
--	---	-----------------------------

Percent Dry Weight (Solids) per Standard Methods - Quality Control

North Creek Analytical - Portland

Analyte	Result	Reporting Limit	Units	Spike Level	Source Result	%REC	%REC Limits	RPD	RPD Limit	Notes
---------	--------	-----------------	-------	-------------	---------------	------	-------------	-----	-----------	-------

Batch 4040273 - Dry Weight

Duplicate (4040273-DUP1)	Source: P4D0112-03		Prepared: 04/07/04 Analyzed: 04/08/04							
% Solids	65.5	1.00 % by Weight			65.7			0.305	20	
Duplicate (4040273-DUP2)	Source: P4D0112-05		Prepared: 04/07/04 Analyzed: 04/08/04							
% Solids	67.3	1.00 % by Weight			67.0			0.447	20	
Duplicate (4040273-DUP3)	Source: P4D0112-09		Prepared: 04/07/04 Analyzed: 04/08/04							
% Solids	63.2	1.00 % by Weight			63.0			0.317	20	
Duplicate (4040273-DUP4)	Source: P4D0114-02		Prepared: 04/07/04 Analyzed: 04/08/04							
% Solids	90.0	1.00 % by Weight			89.8			0.222	20	
Duplicate (4040273-DUP5)	Source: P4D0124-01		Prepared: 04/07/04 Analyzed: 04/08/04							
% Solids	90.8	1.00 % by Weight			90.7			0.110	20	

North Creek Analytical - Portland

Lisa Domenighini, Project Manager

The results in this report apply to the samples analyzed in accordance with the chain of custody document. This analytical report must be reproduced in its entirety.



Seattle 11720 North Creek Pkwy N, Suite 400, Bothell, WA 98011-9223
 425.420.9200 fax 425.420.9210
Spokane East 11115 Montgomery, Suite B, Spokane, WA 99206-4776
 509.924.9200 fax 509.924.9290
Portland 9405 SW Nimbus Avenue, Beaverton, OR 97008-7132
 503.906.9200 fax 503.906.9210
Bend 20332 Empire Avenue, Suite F-1, Bend, OR 97701-5711
 541.383.9310 fax 541.382.7588

Hart Crowser
 Five Centerpointe Drive
 Lake Oswego, OR 97035

Project: Astoria Area-Wide Petroleum Site
 Project Number: 15227
 Project Manager: Leon Lahiere

Reported:
 04/28/04 16:21

Notes and Definitions

- A-01 Detected hydrocarbons have distinct peaks that have elution patterns similar to that of PAH's, as well as other extraneous peaks that may be due to biogenic interference.
- A-05 Sample analyzed out of hold due to low analyte recovery in initial analysis.
- A-05a Sample analyzed out of hold due to low surrogate recovery in initial analysis.
- D-17 Detected hydrocarbons in the diesel range do not have a distinct diesel pattern and may be due to heavily weathered diesel or possibly biogenic interference.
- O-07 This sample was extracted outside the EPA recommended holding time.
- Q-01 The matrix spike recovery, and/or RPD, for this QC sample is outside of established control limits. Failure of a matrix spike QC sample does not represent an out-of-control condition for the batch.
- Q-02 The matrix spike recovery, and/or RPD, for this QC sample is outside of established control limits due to sample matrix interference.
- Q-16 RPD is not applicable for analyte concentrations less than 5 times the MRL.
- R-05 Reporting limits raised due to dilution necessary for analysis. Sample contains high levels of reported analyte, non-target analyte, and/or matrix interference.
- S-03 Surrogate recovery is outside of NCA established control limits.
- S-09 Surrogate recovery is outside control limits due to matrix interference.
- DET Analyte DETECTED
- ND Analyte NOT DETECTED at or above the reporting limit
- NR Not Reported
- dry Sample results reported on a dry weight basis. MRLs are adjusted if %Solids are less than 50%.
- wet Sample results reported on a wet weight basis (as received)
- RPD Relative Percent Difference

North Creek Analytical - Portland

Lisa Domenighini, Project Manager

The results in this report apply to the samples analyzed in accordance with the chain of custody document. This analytical report must be reproduced in its entirety.



Seattle 11720 North Creek Pkwy N, Suite 400, Bothell, WA 98011-9223
425.420.9200 fax 425.420.9210
Spokane East 11115 Montgomery, Suite B, Spokane, WA 99206-4776
509.924.9200 fax 509.924.9290
Portland 9405 SW Nimbus Avenue, Beaverton, OR 97008-7132
503.906.9200 fax 503.906.9210
Bend 20332 Empire Avenue, Suite F-1, Bend, OR 97701-5711
541.383.9310 fax 541.382.7588

Hart Crowser
Five Centerpointe Drive
Lake Oswego, OR 97035

Project: Astoria Area-Wide Petroleum Site
Project Number: 15227
Project Manager: Leon Lahiere

Reported:
04/28/04 16:21

North Creek Analytical - Portland

Lisa Domenighini, Project Manager

The results in this report apply to the samples analyzed in accordance with the chain of custody document. This analytical report must be reproduced in its entirety.

North Creek Analytical, Inc.
Environmental Laboratory Network

Page 18 of 18



11720 North Creek Pkwy N Suite 400, Bothell, WA 98011-9508
 11115 E Montgomery Suite B, Spokane, WA 99206-4776
 9405 SW Nimbus Ave, Beaverton, OR 97008-7132
 20332 Empire Ave Suite F-1, Bend, OR 97701-5711
 3209 Denali St, Anchorage, AK 99503-4030

425-420-9200 FAX 420-9210
 509-924-9200 FAX 924-9290
 503-906-9200 FAX 906-9210
 541-383-9310 FAX 382-7588
 907-334-9200 FAX 334-9210

CHAIN OF CUSTODY REPORT 'Shell-Rates'

Work Order #: **RYD0124**

CLIENT: **HARRISON**
 REPORT TO: **Leon Lahione**
 ADDRESS: **Two Courthouse Drive Suite 240
 LAKEOSWEGO OR 97035**
 PHONE: **503-620-7284** FAX: **503-620-6919**
 PROJECT NAME: **Port of Astoria-SMell**
 PROJECT NUMBER: **15227-00**

INVOICE TO: **Shell Oil Company**
Attn: Ed Platt III, Em. 1442
P.O. Box 2463
Houston, TX 77252-2463
 P.O. NUMBER: **As for Area-Wide Site**

TURNAROUND REQUEST
 in Business Days *
 Organic & Inorganic Analyses
 Petroleum Hydrocarbon Analyses
 STD. 4 3 2 1 <1
 STD. 7 5 4 3 2 1 <1

CLIENT SAMPLE IDENTIFICATION	SAMPLING DATE/TIME	REQUESTED ANALYSES											
		TPH-HD	TPH-DX	TPH-GX	RBOM	VOCs	PAHs	Lead	BTX	MATRIX (W, S, O)	# OF CONT.	LOCATION / COMMENTS	NCA WO ID
EX-1/S-1	3-30-04 / 1129	X	X	X	X	X	X	X	X	S	3		
EX-2/S-1	3-30-04 / 1318	X	X	X	X	X	X	X	X	S	3		
EX-2/S-2	4-10-04 / 0800	X	X	X	X	X	X	X	X	S	3		
EX-3/S-4	3-31-04 / 805	X	X	X	X	X	X	X	X	S	3		
EX-4/S-1	3-29-04 / 1109	X	X	X	X	X	X	X	X	S	3		
6													
7													
8													
9													
10													

OTHER Specify:
 * Turnaround Requests less than standard may incur Rush Charges.

RELEASED BY: **[Signature]** DATE: **4-2-04** RECEIVED BY: **[Signature]** DATE: **4-2-04**
 PRINT NAME: **DIANNA HAMERSON** FIRM: **NCA** PRINT NAME: **Sarah Peterson** FIRM: **NCA**
 RELEASED BY: DATE: TIME: RECEIVED BY: DATE: TIME:
 PRINT NAME: FIRM: PRINT NAME: FIRM:
 ADDITIONAL REMARKS: **Follow-up HCLD with TPH-DX, GX if TPH detected.**
Follow-up TPH-GX, DX with BTX, PAHs, VOCs, Lead as appropriate
Contact Leon Lahione to discuss specific follow-up analyses.
 COC REV. / JOB: TEMP: **21** PAGE: **1** OF **1**



APR 27 2004

Portland Office

Seattle 11720 North Creek Pkwy N, Suite 400, Bothell, WA 98011-9223
425.420.9200 fax 425.420.9210

Spokane East 11115 Montgomery, Suite B, Spokane, WA 99206-4776
509.924.9200 fax 509.924.9290

Portland 9405 SW Nimbus Avenue, Beaverton, OR 97008-7132
503.906.9200 fax 503.906.9210

Bend 20332 Empire Avenue, Suite F-1, Bend, OR 97701-5711
541.383.9310 fax 541.382.7588

Hart Crowser
Five Centerpointe Drive
Lake Oswego, OR 97035

Project: Astoria Area-Wide Petroleum Site
Project Number: 15227
Project Manager: Leon Lahiere

Reported:
04/23/04 14:35

ANALYTICAL REPORT FOR SAMPLES

Sample ID	Laboratory ID	Matrix	Date Sampled	Date Received
SB-915(s)-5.0	P4D0071-01	Soil	03/31/04 10:20	04/01/04 14:00
SB-916(s)-5.0	P4D0071-02	Soil	03/31/04 09:30	04/01/04 14:00
SB-917(s)-5.0	P4D0071-03	Soil	03/31/04 09:50	04/01/04 14:00
SB-918(s)-5.0	P4D0071-04	Soil	03/31/04 10:46	04/01/04 14:00
SB-919(s)-5.0	P4D0071-05	Soil	03/31/04 11:05	04/01/04 14:00

North Creek Analytical - Portland

The results in this report apply to the samples analyzed in accordance with the chain of custody document. This analytical report must be reproduced in its entirety.

Crystal Jones For Lisa Domenighini, Project Manager

North Creek Analytical, Inc.
Environmental Laboratory Network

Page 1 of 11



Seattle 11720 North Creek Pkwy N, Suite 400, Bothell, WA 98011-9223
425.420.9200 fax 425.420.9210
Spokane East 11115 Montgomery, Suite B, Spokane, WA 99206-4776
509.924.9200 fax 509.924.9290
Portland 9405 SW Nimbus Avenue, Beaverton, OR 97008-7132
503.906.9200 fax 503.906.9210
Bend 20332 Empire Avenue, Suite F-1, Bend, OR 97701-5711
541.383.9310 fax 541.382.7588

Hart Crowser Five Centerpointe Drive Lake Oswego, OR 97035	Project: Astoria Area-Wide Petroleum Site Project Number: 15227 Project Manager: Leon Lahiere	Reported: 04/23/04 14:35
--	---	-----------------------------

**Hydrocarbon Identification per NW-TPH Methodology
North Creek Analytical - Portland**

Analyte	Result	Reporting Limit	Units	Dilution	Method	Prepared	Analyzed	Batch	Notes
SB-915(s)-5.0 (P4D0071-01) Soil					Sampled: 03/31/04 Received: 04/01/04				
Gasoline Range Hydrocarbons	ND	20.0	mg/kg dry	1	NWTPH HCID	04/05/04	04/05/04	4040126	
Diesel Range Hydrocarbons	ND	50.0	"	"	"	"	"	"	
Heavy Oil Range Hydrocarbons	DET	100	"	"	"	"	"	"	
<i>Surr: 1-Chlorooctadecane</i>	117 %	50-150							
SB-916(s)-5.0 (P4D0071-02) Soil					Sampled: 03/31/04 Received: 04/01/04				
Gasoline Range Hydrocarbons	ND	20.0	mg/kg dry	1	NWTPH HCID	04/05/04	04/05/04	4040126	
Diesel Range Hydrocarbons	ND	50.0	"	"	"	"	"	"	
Heavy Oil Range Hydrocarbons	ND	100	"	"	"	"	"	"	
<i>Surr: 1-Chlorooctadecane</i>	119 %	50-150							
SB-917(s)-5.0 (P4D0071-03) Soil					Sampled: 03/31/04 Received: 04/01/04				
Gasoline Range Hydrocarbons	ND	20.0	mg/kg dry	1	NWTPH HCID	04/05/04	04/05/04	4040126	
Diesel Range Hydrocarbons	ND	50.0	"	"	"	"	"	"	
Heavy Oil Range Hydrocarbons	ND	100	"	"	"	"	"	"	
<i>Surr: 1-Chlorooctadecane</i>	120 %	50-150							
SB-918(s)-5.0 (P4D0071-04) Soil					Sampled: 03/31/04 Received: 04/01/04				
Gasoline Range Hydrocarbons	ND	20.0	mg/kg dry	1	NWTPH HCID	04/05/04	04/05/04	4040126	
Diesel Range Hydrocarbons	ND	50.0	"	"	"	"	"	"	
Heavy Oil Range Hydrocarbons	ND	100	"	"	"	"	"	"	
<i>Surr: 1-Chlorooctadecane</i>	115 %	50-150							
SB-919(s)-5.0 (P4D0071-05) Soil					Sampled: 03/31/04 Received: 04/01/04				
Gasoline Range Hydrocarbons	ND	20.0	mg/kg dry	1	NWTPH HCID	04/05/04	04/05/04	4040126	
Diesel Range Hydrocarbons	ND	50.0	"	"	"	"	"	"	
Heavy Oil Range Hydrocarbons	ND	100	"	"	"	"	"	"	
<i>Surr: 1-Chlorooctadecane</i>	122 %	50-150							

North Creek Analytical - Portland

The results in this report apply to the samples analyzed in accordance with the chain of custody document. This analytical report must be reproduced in its entirety.

Crystal Jones For Lisa Domenighini, Project Manager

**North Creek Analytical, Inc.
Environmental Laboratory Network**

Page 2 of 11



Seattle 11720 North Creek Pkwy N, Suite 400, Bothell, WA 98011-9223
 425.420.9200 fax 425.420.9210
Spokane East 11115 Montgomery, Suite B, Spokane, WA 99206-4776
 509.924.9200 fax 509.924.9290
Portland 9405 SW Nimbus Avenue, Beaverton, OR 97008-7132
 503.906.9200 fax 503.906.9210
Bend 20332 Empire Avenue, Suite F-1, Bend, OR 97701-5711
 541.383.9310 fax 541.382.7588

Hart Crowser
 Five Centerpointe Drive
 Lake Oswego, OR 97035

Project: Astoria Area-Wide Petroleum Site
 Project Number: 15227
 Project Manager: Leon Lahiere

Reported:
 04/23/04 14:35

**Diesel and Heavy Range Hydrocarbons per NWTPH-Dx Method
 North Creek Analytical - Portland**

Analyte	Result	Reporting Limit	Units	Dilution	Method	Prepared	Analyzed	Batch	Notes
SB-915(s)-5.0 (P4D0071-01) Soil					Sampled: 03/31/04 Received: 04/01/04				
Diesel Range Organics	ND	25.0	mg/kg dry	1	NWTPH-Dx	04/09/04	04/12/04	4040340	
Heavy Oil Range Hydrocarbons	294	50.0	"	"	"	"	"	"	
<i>Surr: 1-Chlorooctadecane</i>	96.2 %	50-150							

North Creek Analytical - Portland

The results in this report apply to the samples analyzed in accordance with the chain of custody document. This analytical report must be reproduced in its entirety.

Crystal Jones For Lisa Domenighini, Project Manager

North Creek Analytical, Inc.
Environmental Laboratory Network



Seattle 11720 North Creek Pkwy N, Suite 400, Bothell, WA 98011-9223
 425.420.9200 fax 425.420.9210
Spokane East 11115 Montgomery, Suite B, Spokane, WA 99206-4776
 509.924.9200 fax 509.924.9290
Portland 9405 SW Nimbus Avenue, Beaverton, OR 97008-7132
 503.906.9200 fax 503.906.9210
Bend 20332 Empire Avenue, Suite F-1, Bend, OR 97701-5711
 541.383.9310 fax 541.382.7588

Hart Crowser
 Five Centerpointe Drive
 Lake Oswego, OR 97035

Project: Astoria Area-Wide Petroleum Site
 Project Number: 15227
 Project Manager: Leon Lahiere

Reported:
 04/23/04 14:35

Polynuclear Aromatic Compounds per EPA 8270M-SIM
North Creek Analytical - Portland

Analyte	Result	Reporting Limit	Units	Dilution	Method	Prepared	Analyzed	Batch	Notes
SB-915(s)-5.0 (P4D0071-01) Soil						Sampled: 03/31/04		Received: 04/01/04	R-05
Acenaphthene	ND	67.0	ug/kg dry	2	EPA 8270m	04/14/04	04/16/04	4040522	
Acenaphthylene	ND	67.0	"	"	"	"	"	"	
Anthracene	ND	67.0	"	"	"	"	"	"	
Benzo (a) anthracene	ND	67.0	"	"	"	"	"	"	
Benzo (a) pyrene	ND	67.0	"	"	"	"	"	"	
Benzo (b) fluoranthene	ND	67.0	"	"	"	"	"	"	
Benzo (ghi) perylene	ND	67.0	"	"	"	"	"	"	
Benzo (k) fluoranthene	ND	67.0	"	"	"	"	"	"	
Chrysene	ND	67.0	"	"	"	"	"	"	
Dibenzo (a,h) anthracene	ND	67.0	"	"	"	"	"	"	
Fluoranthene	ND	67.0	"	"	"	"	"	"	
Fluorene	ND	67.0	"	"	"	"	"	"	
Indeno (1,2,3-cd) pyrene	ND	67.0	"	"	"	"	"	"	
Naphthalene	ND	67.0	"	"	"	"	"	"	
Phenanthrene	ND	67.0	"	"	"	"	"	"	
Pyrene	ND	67.0	"	"	"	"	"	"	
Surr: Fluorene-d10	77.3 %	40-150							
Surr: Pyrene-d10	89.6 %	40-150							
Surr: Benzo (a) pyrene-d12	80.9 %	40-150							

North Creek Analytical - Portland

The results in this report apply to the samples analyzed in accordance with the chain of custody document. This analytical report must be reproduced in its entirety.

Crystal Jones For Lisa Domenighini, Project Manager

North Creek Analytical, Inc.
 Environmental Laboratory Network



Seattle 11720 North Creek Pkwy N, Suite 400, Bothell, WA 98011-9223
 425.420.9200 fax 425.420.9210
Spokane East 11115 Montgomery, Suite B, Spokane, WA 99206-4776
 509.924.9200 fax 509.924.9290
Portland 9405 SW Nimbus Avenue, Beaverton, OR 97008-7132
 503.906.9200 fax 503.906.9210
Bend 20332 Empire Avenue, Suite F-1, Bend, OR 97701-5711
 541.383.9310 fax 541.382.7588

Hart Crowser
 Five Centerpointe Drive
 Lake Oswego, OR 97035

Project: Astoria Area-Wide Petroleum Site
 Project Number: 15227
 Project Manager: Leon Lahiere

Reported:
 04/23/04 14:35

**Percent Dry Weight (Solids) per Standard Methods
 North Creek Analytical - Portland**

Analyte	Result	Reporting Limit	Units	Dilution	Method	Prepared	Analyzed	Batch	Notes
SB-915(s)-5.0 (P4D0071-01) Soil						Sampled: 03/31/04 Received: 04/01/04			
% Solids	85.9	1.00	% by Weight	1	NCA SOP	04/07/04	04/08/04	4040273	
SB-916(s)-5.0 (P4D0071-02) Soil						Sampled: 03/31/04 Received: 04/01/04			
% Solids	82.1	1.00	% by Weight	1	NCA SOP	04/07/04	04/08/04	4040273	
SB-917(s)-5.0 (P4D0071-03) Soil						Sampled: 03/31/04 Received: 04/01/04			
% Solids	82.1	1.00	% by Weight	1	NCA SOP	04/07/04	04/08/04	4040273	
SB-918(s)-5.0 (P4D0071-04) Soil						Sampled: 03/31/04 Received: 04/01/04			
% Solids	87.4	1.00	% by Weight	1	NCA SOP	04/07/04	04/08/04	4040273	
SB-919(s)-5.0 (P4D0071-05) Soil						Sampled: 03/31/04 Received: 04/01/04			
% Solids	85.9	1.00	% by Weight	1	NCA SOP	04/07/04	04/08/04	4040273	

North Creek Analytical - Portland

The results in this report apply to the samples analyzed in accordance with the chain of custody document. This analytical report must be reproduced in its entirety.

Crystal Jones For Lisa Domenighini, Project Manager

**North Creek Analytical, Inc.
 Environmental Laboratory Network**



Seattle 11720 North Creek Pkwy N, Suite 400, Bothell, WA 98011-9223
425.420.9200 fax 425.420.9210
Spokane East 11115 Montgomery, Suite B, Spokane, WA 99206-4776
509.924.9200 fax 509.924.9290
Portland 9405 SW Nimbus Avenue, Beaverton, OR 97008-7132
503.906.9200 fax 503.906.9210
Bend 20332 Empire Avenue, Suite F-1, Bend, OR 97701-5711
541.383.9310 fax 541.382.7588

Hart Crowser
Five Centerpointe Drive
Lake Oswego, OR 97035

Project: Astoria Area-Wide Petroleum Site
Project Number: 15227
Project Manager: Leon Lahiere

Reported:
04/23/04 14:35

Hydrocarbon Identification per NW-TPH Methodology - Quality Control

North Creek Analytical - Portland

Analyte	Result	Reporting Limit	Units	Spike Level	Source Result	%REC	%REC Limits	RPD	RPD Limit	Notes
Batch 4040126 - TPH-HCID Extraction										
Blank (4040126-BLK1)				Prepared & Analyzed: 04/05/04						
Gasoline Range Hydrocarbons	ND	20.0	mg/kg							
Diesel Range Hydrocarbons	ND	50.0	"							
Heavy Oil Range Hydrocarbons	ND	100	"							
<i>Surr: 1-Chlorooctadecane</i>	<i>DET</i>		"	9.60		125	50-150			
Duplicate (4040126-DUP1)				Source: P4D0045-13		Prepared: 04/05/04 Analyzed: 04/06/04				
Gasoline Range Hydrocarbons	14.0	20.0	mg/kg dry		29.2			70.4	50	Q-16
Diesel Range Hydrocarbons	ND	50.0	"		13.6				50	
Heavy Oil Range Hydrocarbons	ND	100	"		ND			NA	50	
<i>Surr: 1-Chlorooctadecane</i>	<i>DET</i>		"	12.3		109	50-150			
Duplicate (4040126-DUP2)				Source: P4D0045-14		Prepared & Analyzed: 04/05/04				
Gasoline Range Hydrocarbons	ND	20.0	mg/kg dry		ND			NA	50	
Diesel Range Hydrocarbons	ND	50.0	"		ND			NA	50	
Heavy Oil Range Hydrocarbons	ND	100	"		ND			NA	50	
<i>Surr: 1-Chlorooctadecane</i>	<i>DET</i>		"	13.0		98.5	50-150			

North Creek Analytical - Portland

The results in this report apply to the samples analyzed in accordance with the chain of custody document. This analytical report must be reproduced in its entirety.

Crystal Jones For Lisa Domenighini, Project Manager

North Creek Analytical, Inc.
Environmental Laboratory Network



Seattle 11720 North Creek Pkwy N, Suite 400, Bothell, WA 98011-9223
 425.420.9200 fax 425.420.9210
Spokane East 11115 Montgomery, Suite B, Spokane, WA 99206-4776
 509.924.9200 fax 509.924.9290
Portland 9405 SW Nimbus Avenue, Beaverton, OR 97008-7132
 503.906.9200 fax 503.906.9210
Bend 20332 Empire Avenue, Suite F-1, Bend, OR 97701-5711
 541.383.9310 fax 541.382.7588

Hart Crowser Five Centerpointe Drive Lake Oswego, OR 97035	Project: Astoria Area-Wide Petroleum Site Project Number: 15227 Project Manager: Leon Lahiere	Reported: 04/23/04 14:35
--	---	-----------------------------

Diesel and Heavy Range Hydrocarbons per NWTPH-Dx Method - Quality Control

North Creek Analytical - Portland

Analyte	Result	Reporting Limit	Units	Spike Level	Source Result	%REC	%REC Limits	RPD	RPD Limit	Notes
---------	--------	-----------------	-------	-------------	---------------	------	-------------	-----	-----------	-------

Batch 4040340 - EPA 3550 Fuels

Blank (4040340-BLK1)				Prepared & Analyzed: 04/09/04						
Diesel Range Organics	ND	25.0	mg/kg							
Heavy Oil Range Hydrocarbons	ND	50.0	"							
<i>Surr: 1-Chlorooctadecane</i>	4.29		"	4.80		89.4	50-150			

LCS (4040340-BS1)				Prepared & Analyzed: 04/09/04						
Diesel Range Organics	123	25.0	mg/kg	125		98.4	50-150			
Heavy Oil Range Hydrocarbons	72.5	50.0	"	75.0		96.7	50-150			
<i>Surr: 1-Chlorooctadecane</i>	5.36		"	4.80		112	50-150			

Duplicate (4040340-DUP1)				Source: P4D0045-06		Prepared & Analyzed: 04/09/04				
Diesel Range Organics	ND	25.0	mg/kg dry		ND			NA	50	
Heavy Oil Range Hydrocarbons	ND	50.0	"		ND			NA	50	
<i>Surr: 1-Chlorooctadecane</i>	5.64		"	6.44		87.6	50-150			

Duplicate (4040340-DUP2)				Source: P4D0045-07		Prepared & Analyzed: 04/09/04				
Diesel Range Organics	ND	25.0	mg/kg dry		ND			NA	50	
Heavy Oil Range Hydrocarbons	ND	50.0	"		ND			NA	50	
<i>Surr: 1-Chlorooctadecane</i>	5.34		"	6.02		88.7	50-150			

North Creek Analytical - Portland

The results in this report apply to the samples analyzed in accordance with the chain of custody document. This analytical report must be reproduced in its entirety.

Crystal Jones For Lisa Domenighini, Project Manager

North Creek Analytical, Inc.
Environmental Laboratory Network



Seattle 11720 North Creek Pkwy N, Suite 400, Bothell, WA 98011-9223
425.420.9200 fax 425.420.9210
Spokane East 11115 Montgomery, Suite B, Spokane, WA 99206-4776
509.924.9200 fax 509.924.9290
Portland 9405 SW Nimbus Avenue, Beaverton, OR 97008-7132
503.906.9200 fax 503.906.9210
Bend 20332 Empire Avenue, Suite F-1, Bend, OR 97701-5711
541.383.9310 fax 541.382.7588

Hart Crowser Five Centerpointe Drive Lake Oswego, OR 97035	Project: Astoria Area-Wide Petroleum Site Project Number: 15227 Project Manager: Leon Lahiere	Reported: 04/23/04 14:35
--	---	-----------------------------

Polynuclear Aromatic Compounds per EPA 8270M-SIM - Quality Control

North Creek Analytical - Portland

Analyte	Result	Reporting Limit	Units	Spike Level	Source Result	%REC	%REC Limits	RPD	RPD Limit	Notes
---------	--------	-----------------	-------	-------------	---------------	------	-------------	-----	-----------	-------

Batch 4040522 - EPA 3550

Blank (4040522-BLK1) Prepared: 04/14/04 Analyzed: 04/16/04

Acenaphthene	ND	13.4	ug/kg							
Acenaphthylene	ND	13.4	"							
Anthracene	ND	13.4	"							
Benzo (a) anthracene	ND	13.4	"							
Benzo (a) pyrene	ND	13.4	"							
Benzo (b) fluoranthene	ND	13.4	"							
Benzo (ghi) perylene	ND	13.4	"							
Benzo (k) fluoranthene	ND	13.4	"							
Chrysene	ND	13.4	"							
Dibenzo (a,h) anthracene	ND	13.4	"							
Fluoranthene	ND	13.4	"							
Fluorene	ND	13.4	"							
Indeno (1,2,3-cd) pyrene	ND	13.4	"							
Naphthalene	ND	13.4	"							
Phenanthrene	ND	13.4	"							
Pyrene	ND	13.4	"							
Surr: Fluorene-d10	64.2		"	83.3		77.1	40-150			
Surr: Pyrene-d10	76.4		"	83.3		91.7	40-150			
Surr: Benzo (a) pyrene-d12	73.0		"	83.3		87.6	40-150			

LCS (4040522-BS1) Prepared: 04/14/04 Analyzed: 04/16/04

Acenaphthene	131	13.4	ug/kg	167		78.4	33-139			
Benzo (a) pyrene	156	13.4	"	167		93.4	45-149			
Pyrene	146	13.4	"	167		87.4	39-138			
Surr: Fluorene-d10	68.9		"	83.3		82.7	40-150			
Surr: Pyrene-d10	74.4		"	83.3		89.3	40-150			
Surr: Benzo (a) pyrene-d12	76.6		"	83.3		92.0	40-150			

North Creek Analytical - Portland

The results in this report apply to the samples analyzed in accordance with the chain of custody document. This analytical report must be reproduced in its entirety.

Crystal Jones For Lisa Domenighini, Project Manager

North Creek Analytical, Inc.
Environmental Laboratory Network



Seattle 11720 North Creek Pkwy N, Suite 400, Bothell, WA 98011-9223
 425.420.9200 fax 425.420.9210
Spokane East 11115 Montgomery, Suite B, Spokane, WA 99206-4776
 509.924.9200 fax 509.924.9290
Portland 9405 SW Nimbus Avenue, Beaverton, OR 97008-7132
 503.906.9200 fax 503.906.9210
Bend 20332 Empire Avenue, Suite F-1, Bend, OR 97701-5711
 541.383.9310 fax 541.382.7588

Hart Crowser Five Centerpointe Drive Lake Oswego, OR 97035	Project: Astoria Area-Wide Petroleum Site Project Number: 15227 Project Manager: Leon Lahiere	Reported: 04/23/04 14:35
--	---	-----------------------------

Polynuclear Aromatic Compounds per EPA 8270M-SIM - Quality Control

North Creek Analytical - Portland

Analyte	Result	Reporting Limit	Units	Spike Level	Source Result	%REC	%REC Limits	RPD	RPD Limit	Notes
---------	--------	-----------------	-------	-------------	---------------	------	-------------	-----	-----------	-------

Batch 4040522 - EPA 3550

Matrix Spike (4040522-MS1)	Source: P4D0071-01		Prepared: 04/14/04		Analyzed: 04/16/04		R-05			
Acenaphthene	156	67.0	ug/kg dry	194	ND	80.4	33-139			
Benzo (a) pyrene	173	67.0	"	194	ND	89.2	45-149			
Pyrene	197	67.0	"	194	ND	102	39-138			
<i>Surr: Fluorene-d10</i>	<i>79.0</i>		<i>"</i>	<i>97.0</i>		<i>81.4</i>	<i>40-150</i>			
<i>Surr: Pyrene-d10</i>	<i>88.2</i>		<i>"</i>	<i>97.0</i>		<i>90.9</i>	<i>40-150</i>			
<i>Surr: Benzo (a) pyrene-d12</i>	<i>81.7</i>		<i>"</i>	<i>97.0</i>		<i>84.2</i>	<i>40-150</i>			

Matrix Spike Dup (4040522-MSD1)	Source: P4D0071-01		Prepared: 04/14/04		Analyzed: 04/16/04		R-05			
Acenaphthene	156	67.0	ug/kg dry	194	ND	80.4	33-139	0.00	60	
Benzo (a) pyrene	174	67.0	"	194	ND	89.7	45-149	0.576	60	
Pyrene	190	67.0	"	194	ND	97.9	39-138	3.62	60	
<i>Surr: Fluorene-d10</i>	<i>79.3</i>		<i>"</i>	<i>97.0</i>		<i>81.8</i>	<i>40-150</i>			
<i>Surr: Pyrene-d10</i>	<i>90.4</i>		<i>"</i>	<i>97.0</i>		<i>93.2</i>	<i>40-150</i>			
<i>Surr: Benzo (a) pyrene-d12</i>	<i>83.1</i>		<i>"</i>	<i>97.0</i>		<i>85.7</i>	<i>40-150</i>			

North Creek Analytical - Portland

The results in this report apply to the samples analyzed in accordance with the chain of custody document. This analytical report must be reproduced in its entirety.

Crystal Jones For Lisa Domenighini, Project Manager

North Creek Analytical, Inc.
Environmental Laboratory Network



Seattle 11720 North Creek Pkwy N, Suite 400, Bothell, WA 98011-9223
 425.420.9200 fax 425.420.9210
Spokane East 11115 Montgomery, Suite B, Spokane, WA 99206-4776
 509.924.9200 fax 509.924.9290
Portland 9405 SW Nimbus Avenue, Beaverton, OR 97008-7132
 503.906.9200 fax 503.906.9210
Bend 20332 Empire Avenue, Suite F-1, Bend, OR 97701-5711
 541.383.9310 fax 541.382.7588

Hart Crowser Five Centerpointe Drive Lake Oswego, OR 97035	Project: Astoria Area-Wide Petroleum Site Project Number: 15227 Project Manager: Leon Lahiere	Reported: 04/23/04 14:35
--	---	-----------------------------

Percent Dry Weight (Solids) per Standard Methods - Quality Control

North Creek Analytical - Portland

Analyte	Result	Reporting Limit	Units	Spike Level	Source Result	%REC	%REC Limits	RPD	RPD Limit	Notes
---------	--------	-----------------	-------	-------------	---------------	------	-------------	-----	-----------	-------

Batch 4040273 - Dry Weight

Duplicate (4040273-DUP1)	Source: P4D0112-03		Prepared: 04/07/04 Analyzed: 04/08/04						
% Solids	65.5	1.00 % by Weight		65.7	0.305	20			
Duplicate (4040273-DUP2)	Source: P4D0112-05		Prepared: 04/07/04 Analyzed: 04/08/04						
% Solids	67.3	1.00 % by Weight		67.0	0.447	20			
Duplicate (4040273-DUP3)	Source: P4D0112-09		Prepared: 04/07/04 Analyzed: 04/08/04						
% Solids	63.2	1.00 % by Weight		63.0	0.317	20			
Duplicate (4040273-DUP4)	Source: P4D0114-02		Prepared: 04/07/04 Analyzed: 04/08/04						
% Solids	90.0	1.00 % by Weight		89.8	0.222	20			
Duplicate (4040273-DUP5)	Source: P4D0124-01		Prepared: 04/07/04 Analyzed: 04/08/04						
% Solids	90.8	1.00 % by Weight		90.7	0.110	20			

North Creek Analytical - Portland

The results in this report apply to the samples analyzed in accordance with the chain of custody document. This analytical report must be reproduced in its entirety.

Crystal Jones For Lisa Domenighini, Project Manager

North Creek Analytical, Inc.
Environmental Laboratory Network

Page 10 of 11



Seattle 11720 North Creek Pkwy N, Suite 400, Bothell, WA 98011-9223
 425.420.9200 fax 425.420.9210
Spokane East 11115 Montgomery, Suite B, Spokane, WA 99206-4776
 509.924.9200 fax 509.924.9290
Portland 9405 SW Nimbus Avenue, Beaverton, OR 97008-7132
 503.906.9200 fax 503.906.9210
Bend 20332 Empire Avenue, Suite F-1, Bend, OR 97701-5711
 541.383.9310 fax 541.382.7588

Hart Crowser Five Centerpointe Drive Lake Oswego, OR 97035	Project: Astoria Area-Wide Petroleum Site Project Number: 15227 Project Manager: Leon Lahiere	Reported: 04/23/04 14:35
--	---	-----------------------------

Notes and Definitions

- Q-16 RPD is not applicable for analyte concentrations less than 5 times the MRL.
- R-05 Reporting limits raised due to dilution necessary for analysis. Sample contains high levels of reported analyte, non-target analyte, and/or matrix interference.
- DET Analyte DETECTED
- ND Analyte NOT DETECTED at or above the reporting limit
- NR Not Reported
- dry Sample results reported on a dry weight basis. MRLs are adjusted if %Solids are less than 50%.
- wet Sample results reported on a wet weight basis (as received)
- RPD Relative Percent Difference

North Creek Analytical - Portland

The results in this report apply to the samples analyzed in accordance with the chain of custody document. This analytical report must be reproduced in its entirety.

Crystal Jones For Lisa Domenighini, Project Manager

North Creek Analytical, Inc.
Environmental Laboratory Network

94007

SHELL OIL COMPANY
RETAIL ENVIRONMENTAL ENGINEERING - WEST
CHAIN OF CUSTODY RECORD
 Date: 3/31/04
 Page 1 of 1

Serial No: _____
 LAB: NCA

Site Address: Part of Astoria, Astoria, OR
 WIC#: _____

Shell Engineer: Ed Platt III
 Phone No: 503-241-5126
 Fax #: 241-7373

Consultant Name & Address: Hart Crowser
5 Centerpointe Dr., Ste 240, Lake Oswego 97035

Consultant Contact: Hart Crowser - Leon Lahiere
 Phone No: (503) 620-7284
 Fax #: 620-6918

Comments: Hart Crowser Job # 15227
 Sampled by: [Signature]

Printed Name: Tim Skotzki

Sample ID	Date	Sludge	Soil	Water	Air	No. of conis.
SB-915(s)-5.0	3/31/04 1020		✓			2
SB-916(s)-5.0	3/31/04 0930		✓			2
SB-917(s)-5.0	3/31/04 0950		✓			2
SB-918(s)-5.0	3/31/04 1016		✓			2
SB-919(s)-5.0	3/31/04 1105		✓			2

Analysis Required	TPH (EPA 8015 Mod. Gas) X NW	TPH (EPA 8015 Mod. Diesel) X - NW	BTEX (EPA 8020/602)	Volatile Organics (EPA 8240)	Test for Disposal	Combination TPH 8015 & BTEX 8020	Mutrit - HClO * with sulfate	Asbestos	Container Size	Preparation Used	Composite Y/N
							X				
							X				
							X				
							X				
							X				

Relinquished By (signature): [Signature] Date: 4/1/04
 Time: 1400
 Relinquished By (signature): [Signature] Date: _____
 Time: _____
 Relinquished By (signature): _____ Date: _____
 Time: _____

Printed Name: Tim Skotzki
 Received (signature): [Signature]
 Date: 4/1/04
 Time: 1400

Printed Name: Kim Davis
 Received (signature): _____
 Date: _____
 Time: _____

Printed Name: _____
 Received (signature): _____
 Date: _____
 Time: _____

4.9 cc 'check'

* with appropriate follow up

AGENCY: OR-DEQ

MATERIAL DESCRIPTION

SAMPLE CONDITION/ COMMENTS

TURN AROUND TIME
 24 hours
 48 hours
 15 days (No/mail)
 Other

NOTE: Notify Lab as soon as Possible of 24/48 hrs. TAT.

CHECK ONE (1) BOX ONLY
 G.W. Monitoring 4461
 Site Investigation 4441
 Soil Classify/Disposal 4442
 Water Classify/Disposal 4443
 Soil/Air Rem. or Syt. O & M 4452
 Water Rem. or Syt. O & M 4453
 Other